

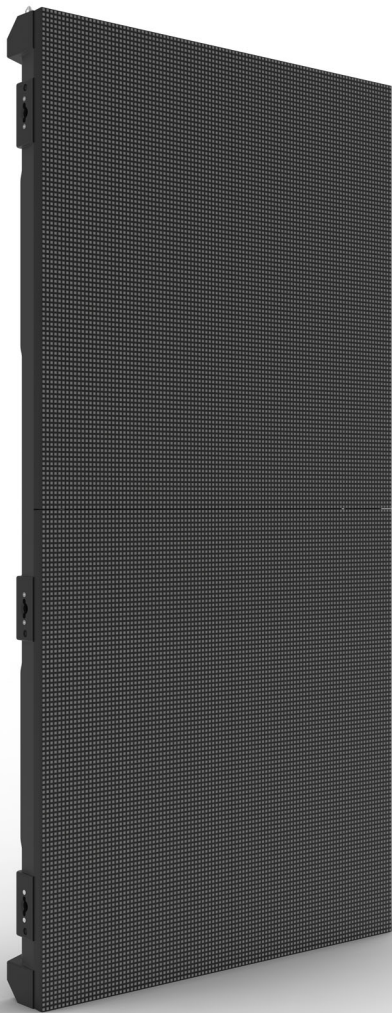

User Manual



Edition Notes

The F4XIP User Manual includes a description, safety precautions, installation, programming, operation and maintenance instructions for the F4XIP as of the release date of this edition.

Trademarks

CHAUVET, the Chauvet logo, and F4XIP are registered trademarks or trademarks of Chauvet & Sons, LLC (d/b/a Chauvet and Chauvet Lighting) in the United States and other countries. Other company and product names and logos referred to herein may be trademarks of their respective companies.

Copyright Notice

The works of authorship contained in this manual, including, but not limited to, all design, text and images are owned by Chauvet.

© **Copyright 2022 Chauvet & Sons, LLC. All rights reserved.**

Electronically published by Chauvet in the United States of America.

Manual Use

Chauvet authorizes its customers to download and print this manual for professional information purposes only. Chauvet expressly prohibits the usage, copy, storage, distribution, modification, or printing of this manual or its content for any other purpose without written consent from Chauvet.

Document Printing

For best results, print this document in color, on letter size paper (8.5 x 11 in), double-sided. If using A4 paper (210 x 297 mm), configure the printer to scale the content accordingly.

Intended Audience

Any person installing, operating, and/or maintaining this product should completely read through the guide that shipped with the product, as well as this manual, before installing, operating, or maintaining this product.

Disclaimer

Chauvet believes that the information contained in this manual is accurate in all respects. However, Chauvet assumes no responsibility and specifically disclaims any and all liability to any party for any loss, damage or disruption caused by any errors or omissions in this document, whether such errors or omissions result from negligence, accident or any other cause. Chauvet reserves the right to revise the content of this document without any obligation to notify any person or company of such revision, however, Chauvet has no obligation to make, and does not commit to make, any such revisions. Download the latest version from www.chauvetprofessional.com.

Document Revision

This F4XIP User Manual is the 1st edition of this document. Go to www.chauvetprofessional.com for the latest version.

TABLE OF CONTENTS

1. Before You Begin	1
What Is Included	1
Claims.....	1
Text Conventions.....	1
Symbols.....	1
Safety Notes	2
Personal Safety	2
Mounting and Rigging.....	2
Power and Wiring	2
Operation.....	2
Expected LED Lifespan	2
2. Introduction	3
Product Description	3
Features.....	3
Required Accessories.....	3
Optional Accessories	3
Available Signal and Power Cables.....	3
Product Overview	4
Pixels per Panel.....	5
Scrambled Pulse-Width Modulation	5
Product Dimensions	6
3. Setup	7
AC Power	7
AC Plug.....	7
Power Linking	7
4. Mounting	8
Orientation	8
Mounting Points.....	8
DRB-F50CM Dual Function Rig Bar Dimensions	9
DRB-F100CM Dual Function Rig Bar Dimensions	9
Mounting with Dual Function Rig Bar (Hanging)	10
Truss Installation.....	11
Mounting with Dual Function Rig Bar (Stacking)	12
Removing the Feet	12
Flat Wall Installation	13
Mounting Points on a Flat Wall	13
Mounting with Steel Struts	13
Spacers (Flat Wall Installation)	14
5. Joining Each F4XIP (Creating a Modular Design).....	15
Vertically Joining the Panels.....	15
Vertical Panel Connection	16
Horizontally Joining the Panels	17
Horizontal Panel Connection	17

6. Connecting (Cabling) Each F4XIP	18
Testing Signal and Power Connections.....	18
Using the F4XIP Test Button	18
Connecting Power and Signal Cables	19
Connecting the Signal Between Joined Panels	19
Custom Resolutions.....	19
Signal Chain Rectangles (F4XIP).....	20
Connecting the Power Between Joined Panels.....	21
7. LED Module Care and Replacement.....	22
F4XIP Modules	22
LED Lot Numbers	22
A and B Modules	22
Calibration Recall.....	22
F4XIP LED Module Removal.....	23
LED Module Thumbscrews.....	23
Removing a Module from the Front	24
Removing a Module from the Rear.....	26
Removing and Replacing the LED Masks	27
8. F4XIP Serviceability	28
9. Typical F4XIP Installation (Hanging)	30
10. Operation	31
Additional Hardware and Software	31
About NovaLCT and SmartLCT.....	31
Description.....	31
Receiver Card Configuration Files.....	31
Updating RCFGX Files (NovaLCT).....	32
Rotating the Video Panel Orientation (NovaLCT).....	33
Updating RCFGX Files (SmartLCT)	34
11. Technical Information	35
F4XIP Maintenance	35
Returns	35
12. Technical Specifications	36
Contact Us	37

Before You Begin

1. Before You Begin

What Is Included

- 4 F4XIP products
- 1 Road case
- 1 Seetronic® Powerkon® IP65 power cable
- 4 Seetronic® Powerkon® IP65 power linking cables
- 4 Seetronic® Etherkon® IP65 signal linking cables
- 5 spare LED masks
- Front service tool
- Quick Reference Guide

Claims

Carefully unpack the product immediately and check the container to make sure all the parts are in the package and are in good condition.



If the box or the contents (the product and included accessories) appear damaged from shipping, or show signs of mishandling, notify the carrier immediately, not Chauvet. Failure to report damage to the carrier immediately may invalidate your claim. In addition, keep the box and contents for inspection.

For other issues, such as missing components or parts, damage not related to shipping, or concealed damage, file a claim with Chauvet within 7 days of delivery.

Text Conventions

Convention	Meaning
1–512	A range of values
50/60	A set of values of which only one can be chosen
Settings	A menu option not to be modified
Menu > Settings	A sequence of menu options to be followed
<ENTER>	A key to be pressed on the product's control panel

Symbols

Symbol	Meaning
	Critical installation, configuration, or operation information. Not following these instructions may make the product not work, cause damage to the product, or cause harm to the operator.
	Important installation or configuration information. The product may not function correctly if this information is not used.
	Useful information.

Safety Notes

Read all the following safety notes before working with this product. These notes contain important information about the installation, usage, and maintenance of this product.



This product contains no user-serviceable parts. Any reference to servicing in this User Manual will only apply to properly trained, certified technicians. Do not open the housing or attempt any repairs.



All applicable local codes and regulations apply to proper installation of this product.

Personal Safety

- Always disconnect the product from the power source before cleaning.
- Always connect the product to a grounded circuit to avoid the risk of electrocution.
- Do not touch the product's housing when operating because it may be very hot.

Mounting and Rigging

- **WARNING:** This product should only be used by competent and qualified persons.
- **DO NOT** submerge this product (IP65). Temporary outdoor operation is fine.
- When using this product in an outdoor environment, use IP65 (or higher) rated power and data cables. Be sure to secure unused power and data ports with attached IP65 covers.
- **CAUTION:** When transferring product from extreme temperature environments, (e.g. cold truck to warm humid ballroom) condensation may form on the internal electronics of the product. To avoid causing a failure, allow product to fully acclimate to the surrounding environment before connecting it to power.
- Mount this product in a location with adequate ventilation, at least 20 in (50 cm) from adjacent surfaces.
- Make sure there are no flammable materials close to this product while it is operating.
- Never carry the product by the power cable or any moving part.

Power and Wiring

- Make sure the power cable is not crimped or damaged.
- Always make sure the product is being connected to the proper voltage in accordance with the specifications in this manual or on the product's specification label.
- To eliminate unnecessary wear and improve its lifespan, during periods of non-use completely disconnect the product from power via breaker or by unplugging it.
- Never connect this product to a dimmer pack or rheostat.
- Never disconnect this product by pulling or tugging on the power cable.

Operation

- Do not operate this product if there is damage on the housing, lenses, or cables. Have the damaged parts replaced by an authorized technician at once.
- Do not cover the service module when operating to avoid internal overheating.
- Operating Temperature: -4 °F to 104 °F (-20 °C to 40 °C)
- In the event of a serious operation problem, stop using this product immediately!



If your Chauvet product requires service, contact Chauvet Technical Support.

Expected LED Lifespan

Over time, use and heat will gradually reduce LED brightness. Clustered LEDs produce more heat than single LEDs, contributing to shorter lifespans if always used at full intensity. The average LED lifespan is 40,000 to 50,000 hours. To extend LED lifespan, maintain proper ventilation around the product, and limit the overall intensity.

2. Introduction

Product Description

The F4XIP is a high performance IP65 outdoor-rated video panel with brilliant SMD 1921 LEDs outputting 5,000 NITS with a dynamic contrast ratio of 3,300:1. Video and images stand out both indoors and outdoors – even in broad daylight. Specialized LED drivers with S-PWM and an impressive display refresh rate of 3,840 Hz enhance on-camera performance. Quick and easy setup is optimized by an advanced light-weight die-cast magnesium housing and magnetic assisted hanging. The magnetic LED modules simplify maintenance and installation by making it both front and rear serviceable. And our fully equipped F4XIP also comes with an included road case and power/data linking cables.

Features

- 4.8 mm pitch outdoor rated video panel in convenient 1000 mm (tall) by 500 mm (wide) form factor (500 x 500 mm available)
- Easily configure and drive content with the VIP Drive 43Nova 2 or the VIP Drive 83R Nova, powered by the Novastar control protocol
- High quality black body LEDs accurately reproduce video at 14-bit grayscale, operating on the A5s receiver card from Novastar (18-bit available)
- High performance digital LED drivers deliver 3840Hz refresh rate and a clear, vibrant image
- Uses specialized LED dimming control via S-PWM ([Scrambled Pulse-Width Modulation](#)), which enhances on-camera performance.
- Intelligent, high speed magnetic LED modules with dedicated memory stores factory calibration, ensuring optimal image quality, color uniformity, and simplifies maintenance by making service fast and easy
- Magnesium die-cast housing makes this product among the lightest and slimmest in its class without compromising strength, capable of hanging up to 23 vertical panels safely
- Specialized frame design allows for overhead hanging, ground stacking, and wall mounting, maximizing installation flexibility and aftermarket front and rear service; simply push out modules from the rear, using the handles, or use the included service tool from the front.
- Front LED surface protective design features prevent damage when handling: 4x stainless steel standing feet to keep the LEDs from touching the floor, specialized LED board design to improve impact resistance up to 3x that of other panels, and resilient led mask design to optimize image viewing angle and uniformity without exposing the LEDs to front or side impacts
- Strong, magnetic assisted hanging makes setting up the panels fast and easy with a minimal crew
- Optimized heat dissipation ensures an even color across the F4XIP
- Dual power supplies increase the stability of the system for redundant receiver card power
- Cable management solutions include angled connectors on panels for easy operation, long cables which can connector horizontally or vertically, and handles on the bottoms of each panel to organize cables and keep them neat
- Ground support system, and concave curving hardware available

Required Accessories

- Required Software: NovaLCT
- Controller (required): VIP Drive 10-5 Nova, VIP Drive 83R Nova
- Compatible Mounting Options: F-series™ Dual Function Rig Bar (0.5 m, 1 m) (truss mounting), M12 Bolt/Clamp (rear or surface mounting), GROUNDSSUPPORT2KIT (floor mounting)

Optional Accessories

- ArKaos Media Master Express + KN software
- Neutrik powerCON cables
- Neutrik etherCON cables
- DRB-100CM
- DRB-50CM
- DRB-CurveX2
- GROUNDSSUPPORT2KIT
- VIDCURVEKIT

Available Signal and Power Cables

Signal cables (Neutrik® etherCON® CAT6 Signal Extensions)

- ETHERCONEXT18IN
- ETHERCONEXT5FT
- ETHERCONEXT10FT
- ETHERCONEXT25FT
- ETHERCONEXT50FT

Power cables (Seetronic® Powerkon Power Extensions)

- IP65 Rated Seetronic® Powerkon Extension, 5 ft
- IP65 Rated Seetronic® Powerkon Extension, 10 ft
- IP65 Rated Seetronic® Powerkon Extension, 25 ft

Product Overview

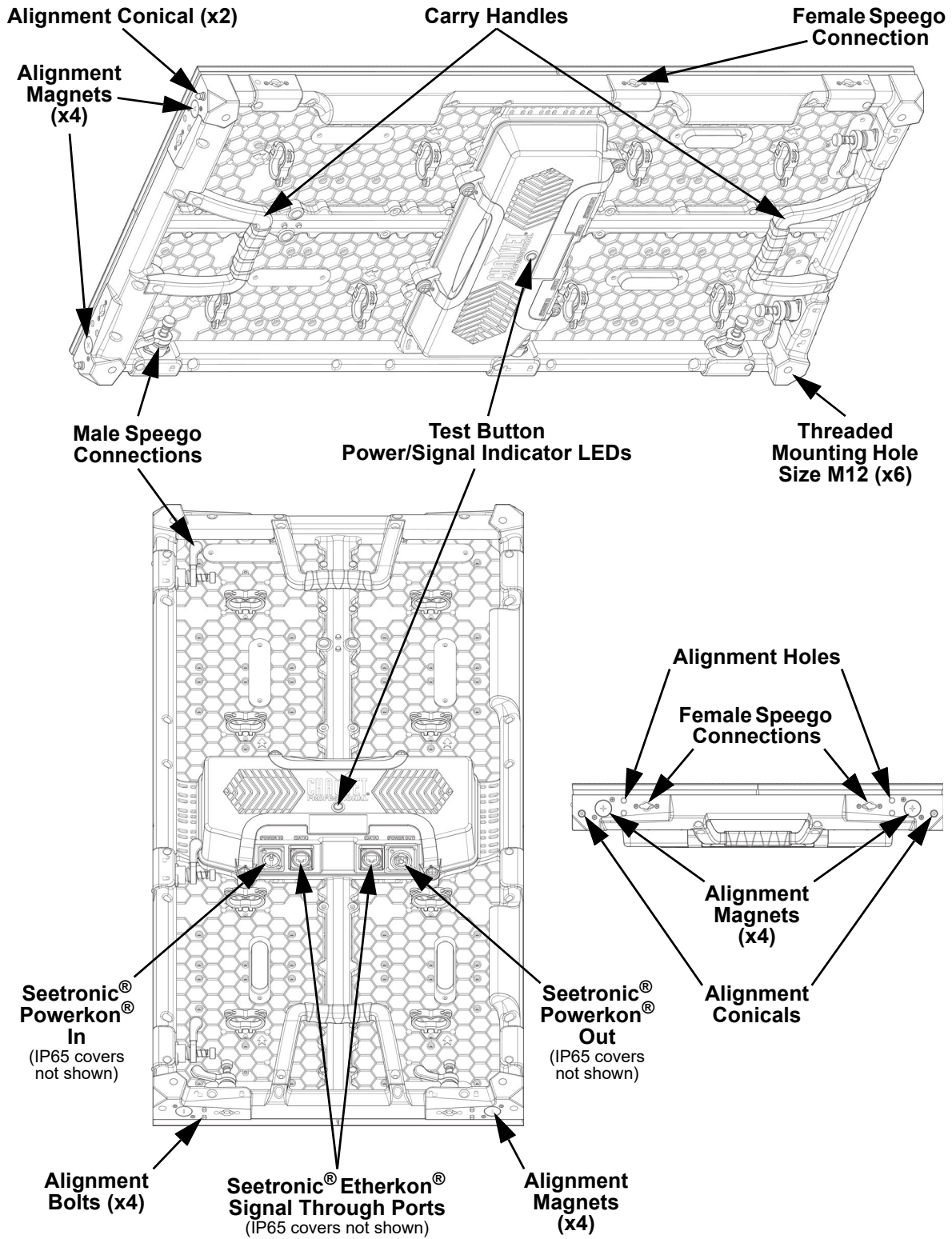

Pixels per Panel

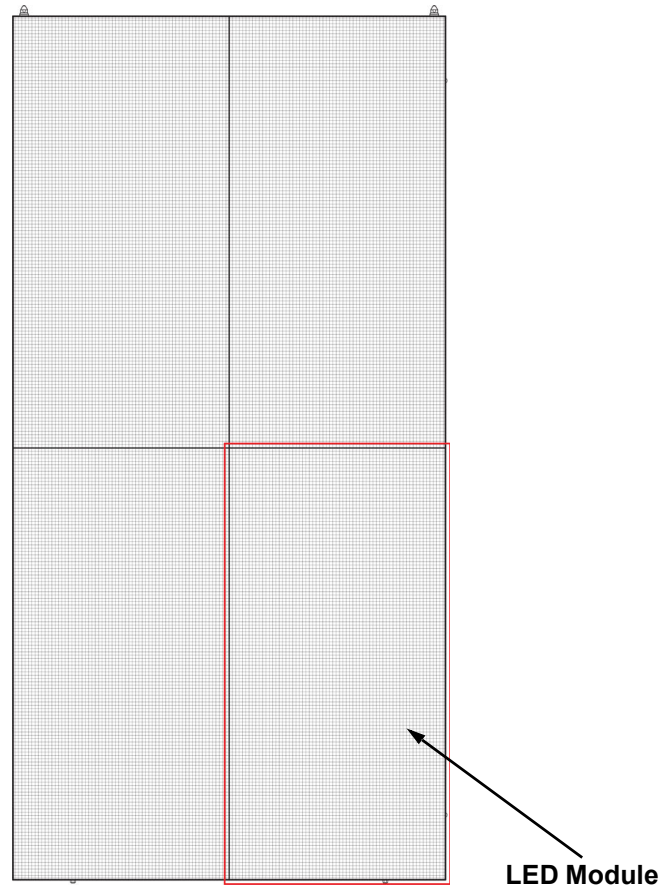

Each pixel is 1 tri-color LED. The following table provides the pixels per panel in each F4XIP. For detailed specifications, refer to the [Technical Specifications](#) table at the end of this User Manual.

Parameter	F4XIP
Pixels per Panel	104 x 208
Total Pixels per Panel	21,632
Pixels per LED Module	52 x 104
Total Pixels per LED Module	5,408
LED Module Dimensions	250 x 500 mm

To calculate the number of panels, horizontally and vertically, supported by a single VIP Drive 10-5 Nova or VIP Drive 83R Nova, you will use:

- The number of pixels per panel.
- The screen resolution you would like to use for your video wall display.



The VIP Drive 10-5 Nova or VIP Drive 83R Nova is required to operate an F4XIP video wall system. Diagrams of how the F4XIP panels and the VIP Drive connect follow later in this manual. For detailed information about the VIP Drive and panel calculation examples, refer to the User Manual for the VIP Drive 10-5 Nova or VIP Drive 83R Nova.

Scrambled Pulse-Width Modulation

This product features Scrambled-PWM (S-PWM) technology, which de-synchronizes the pulse widths of each color of the multi-color LEDs. This ensures that there is always some LED output, reducing flicker, and maintaining the same grayscale performance.

Product Dimensions

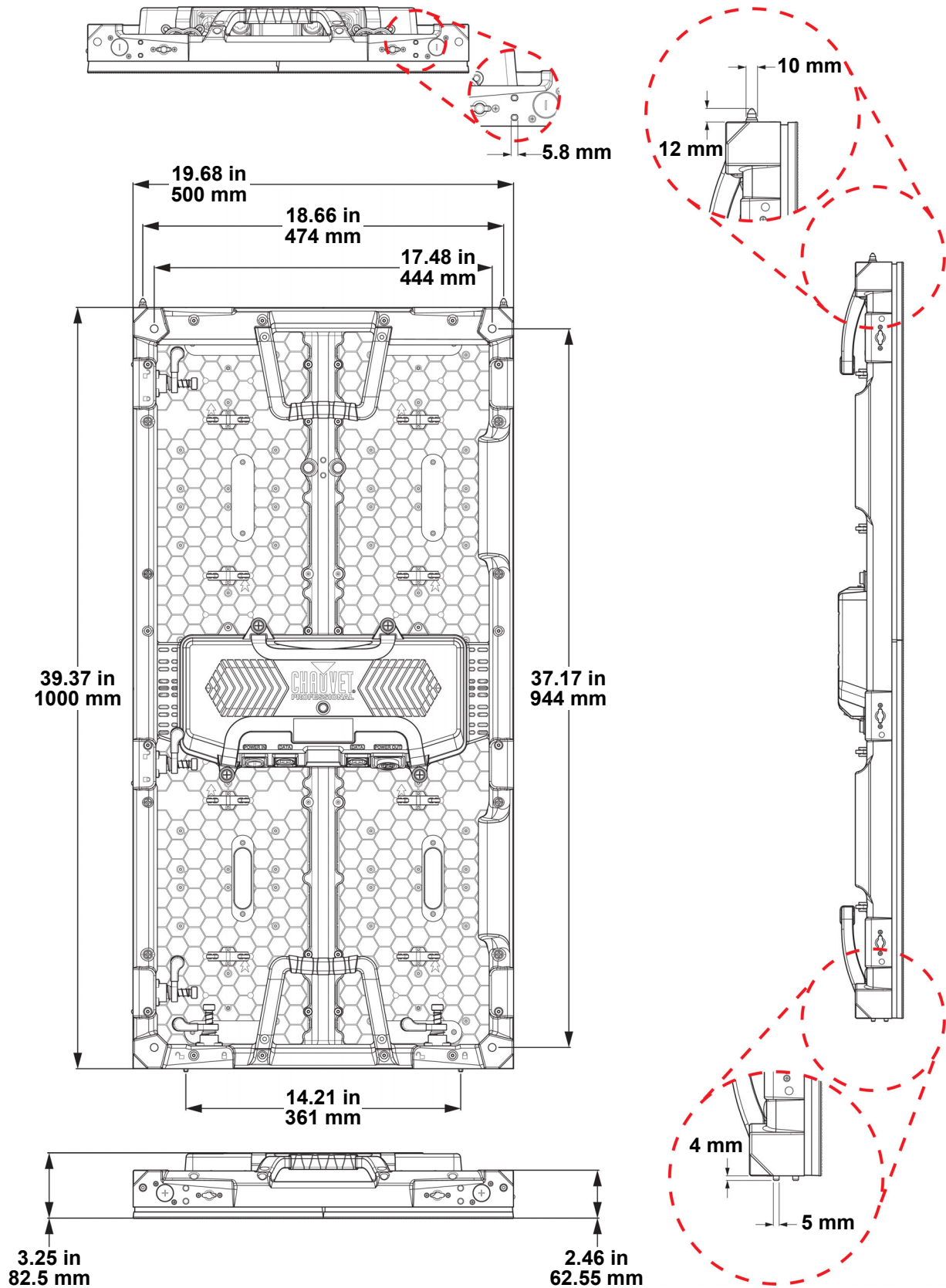

Setup

3. Setup

AC Power

The F4XIP has an auto-ranging power supply and it can work with an input voltage range of 100 to 240 VAC, 50/60 Hz.

To determine the product's power requirements (circuit breaker, power outlet, and wiring), use the current value listed on the label affixed to the product's back panel, or refer to the product's specifications chart. The listed current rating indicates the product's average current draw under normal conditions.



- **Always connect the product to a protected circuit (a circuit breaker or fuse). Make sure the product has an appropriate electrical ground to avoid the risk of electrocution or fire.**
- **To eliminate unnecessary wear and improve its lifespan, during periods of non-use completely disconnect the product from power via breaker or by unplugging it.**



Never connect the product to a rheostat (variable resistor) or dimmer circuit, even if the rheostat or dimmer channel serves only as a 0 to 100% switch.

AC Plug

The F4XIP comes with a power input cable terminated with a Seetronic Powerkon A connector on one end and an Edison plug on the other end (U.S. market). If the power input cable that came with the product has no plug, or if the plug must be changed, use the table below to wire the new plug.

Connection	Wire (U.S.)	Wire (Europe)	Screw Color
AC Live	Black	Brown	Yellow or Brass
AC Neutral	White	Blue	Silver
AC Ground	Green/Yellow	Green/Yellow	Green

Power Linking

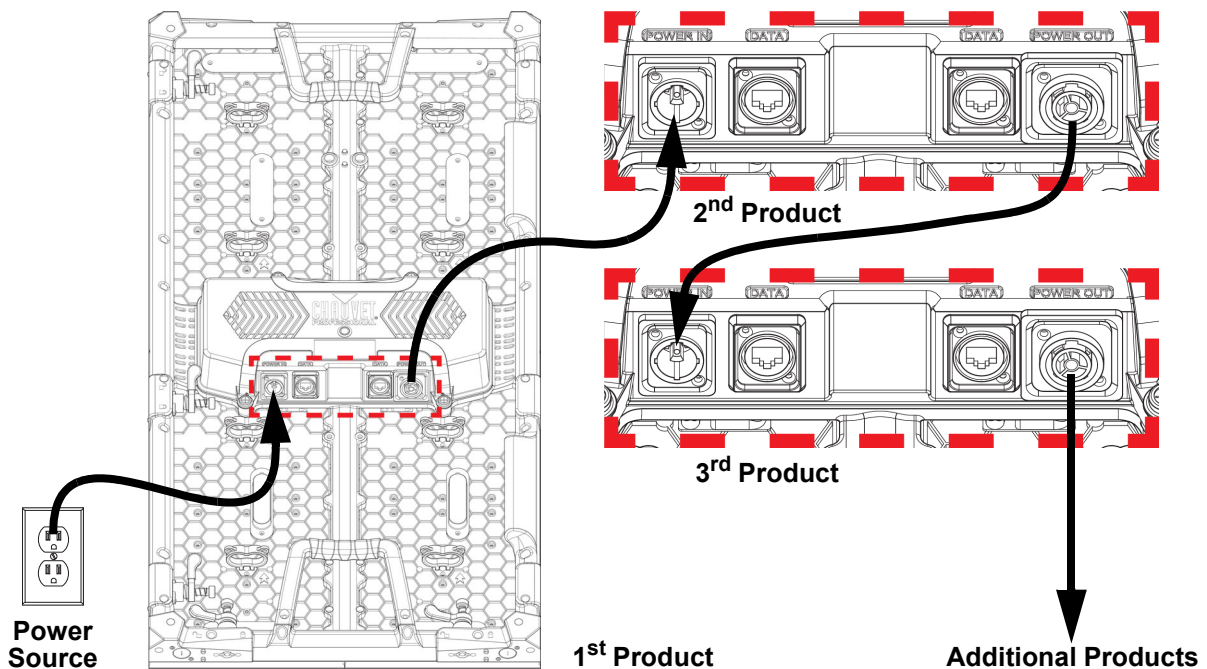

All F4XIP panels support power linking. Refer to the following table for specifications.

Voltage	F4XIP Products
@ 120 V, 60 Hz	5
@ 208 V, 60 Hz	8
@ 230 V, 50 Hz	9



Please refer to all applicable local codes and regulations for the proper installation of this product.

4. Mounting

Orientation

Each F4XIP is constructed of die-cast magnesium. This ensures each panel is stable and easy to install. Each panel also has convenient built-in handles located on the top and bottom of the backside of the panel along with two alignment conicals on the top and 4 alignment bolts (feet) on the bottom. This combination enables you to easily pick up and securely hold each panel while mounting and working with the panels. The F4XIP can be assembled to provide any number of modular designs. The panels on the top can be securely hung from a truss or other stable surface. Always hang in a safe position with adequate space for ventilation, configuration, and maintenance. Chauvet recommends following the general guidelines below.

- When selecting an installation location, consider ease of access for operation and routine maintenance.
- Make sure to hang away from any flammable material, as indicated in the [Safety Notes](#) section.
- Never mount in places where rain, extreme temperature changes, or restricted ventilation may affect it.
- Make sure that the structure and attachment points to which you are hanging the panels can support the weight.
- Make sure that all load-bearing hardware used can support the weight.
- See the [Technical Specifications](#) for the weight requirement of each F4XIP.

Mounting Points

- | |
|--|
| <ol style="list-style-type: none"> 1. Threaded Mounting Holes Size M12 (x6) 2. Male Speego Connection 3. Female Speego Connection 4. Feet (Alignment Bolts) (x4) 5. Handles |
|--|

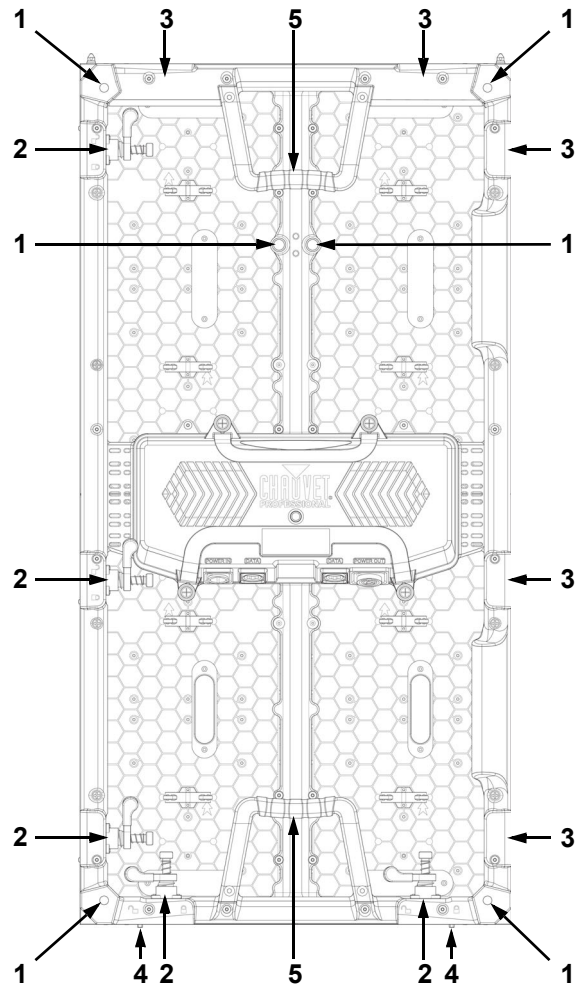

DRB-F50CM Dual Function Rig Bar Dimensions

Sold Separately

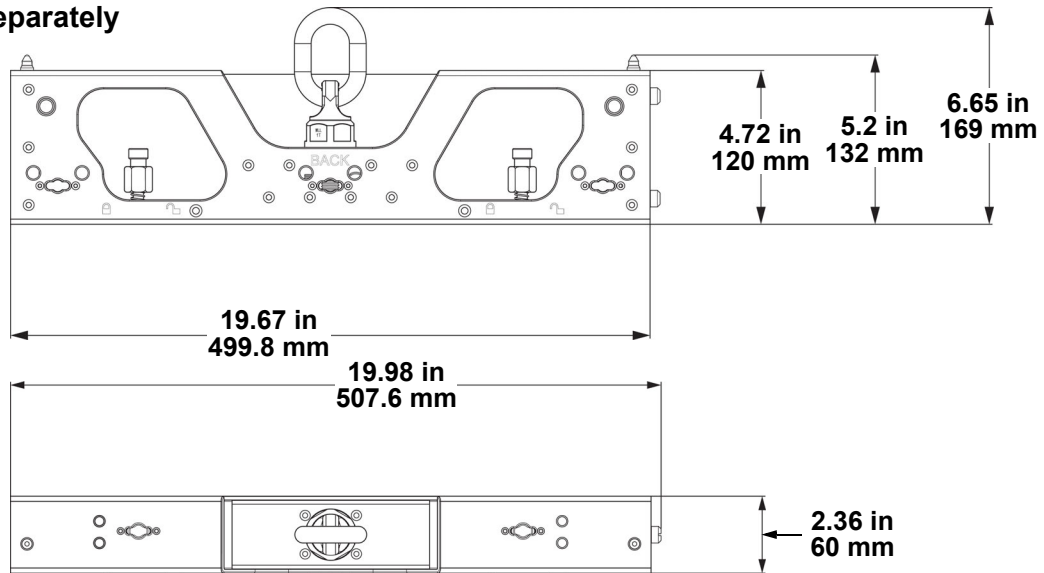

DRB-F100CM Dual Function Rig Bar Dimensions

Sold Separately

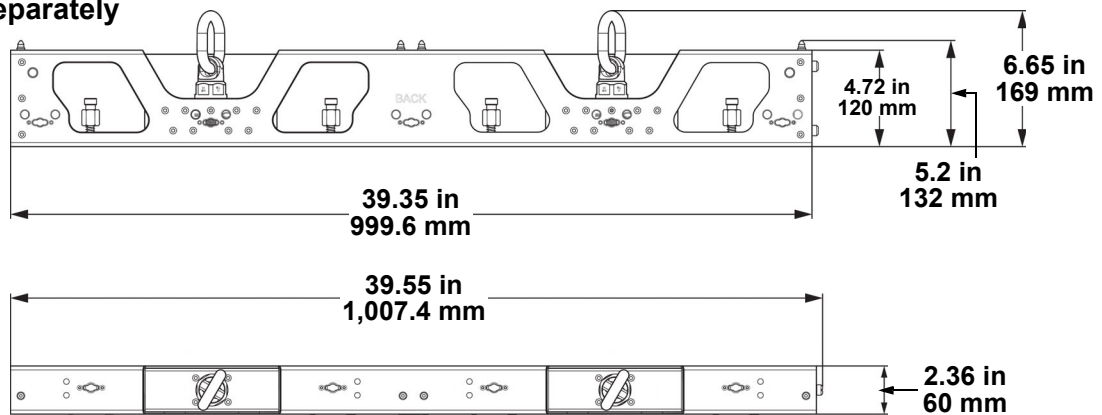

Mounting with Dual Function Rig Bar (Hanging)

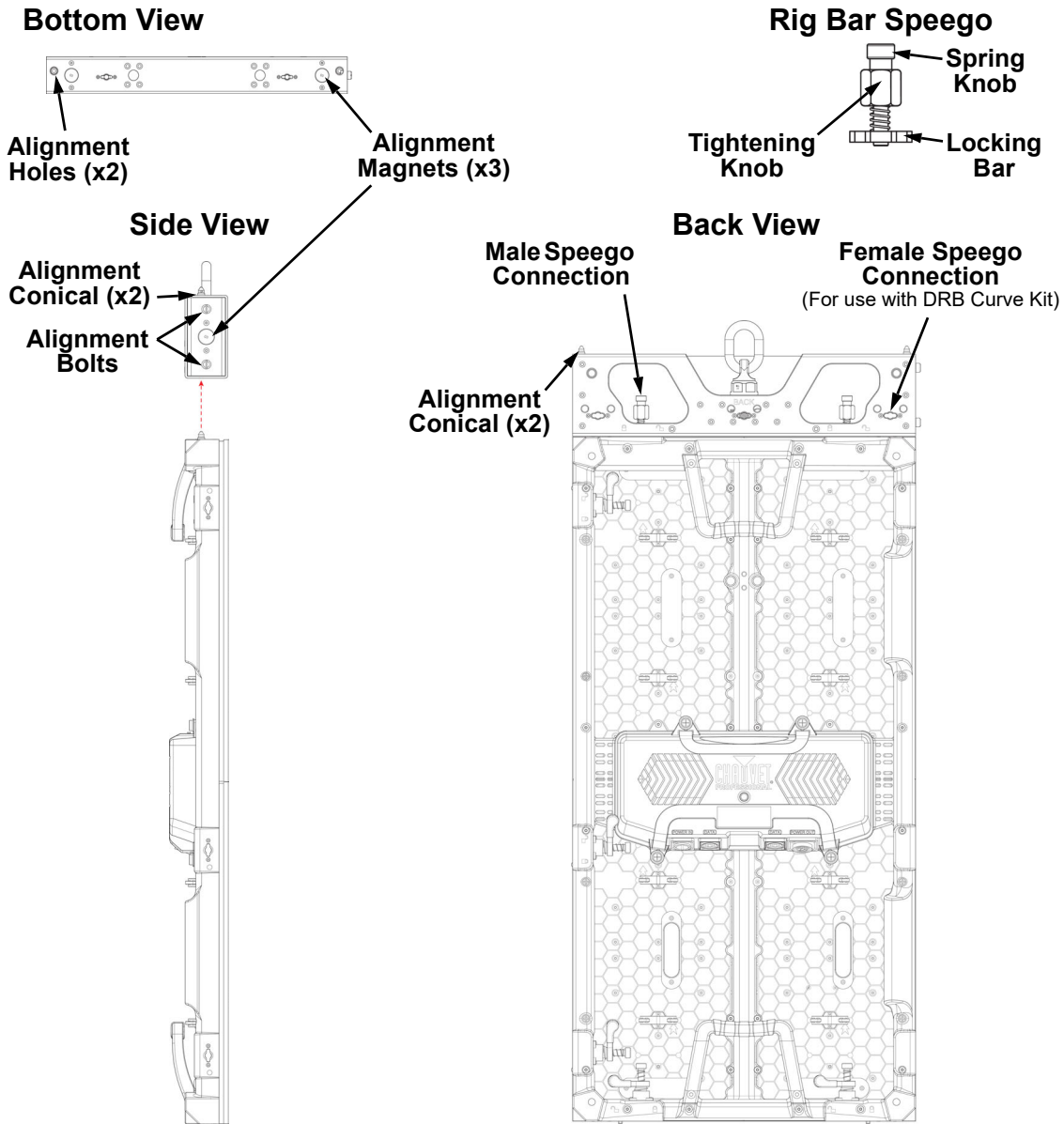

1. Loosen the spring knobs on the male Speego connections of each Rig Bar to be used.
2. Insert alignment conicals into the alignment holes and allow magnets to connect.
3. Insert the Rig Bar Speego locking bars into the female Speego connections on the F4XIP.
4. Twist the spring knob on the Rig Bar Speego until it locks into place.



When mounting a video panel assembly together, mount the entire top row of panels using only the spring knobs before moving on to step 5.

5. Twist the tightening knobs clockwise until the F4XIP products are secure to the Rig Bars and aligned correctly to each other.
6. Install the side latches of the panels to each other ([Horizontal Panel Connection](#)) only after ensuring the alignment is correct.
7. To detach the Rig Bar from the F4XIP, reverse the previous steps. Tilt the panels away from each other to safely release the magnetic attachments.



The alignment magnets on the F4XIP and Dual Function Rig Bar are designed to temporarily hold the weight of the panel to allow the user to properly align and tighten the panel into place.



Warning! The magnetic attachments are not load-bearing, and are intended for alignment assistance only. Do not release panel until the hanging hardware has been fully secured.

Truss Installation

Attach to Truss Using Dual Function Rig Bar

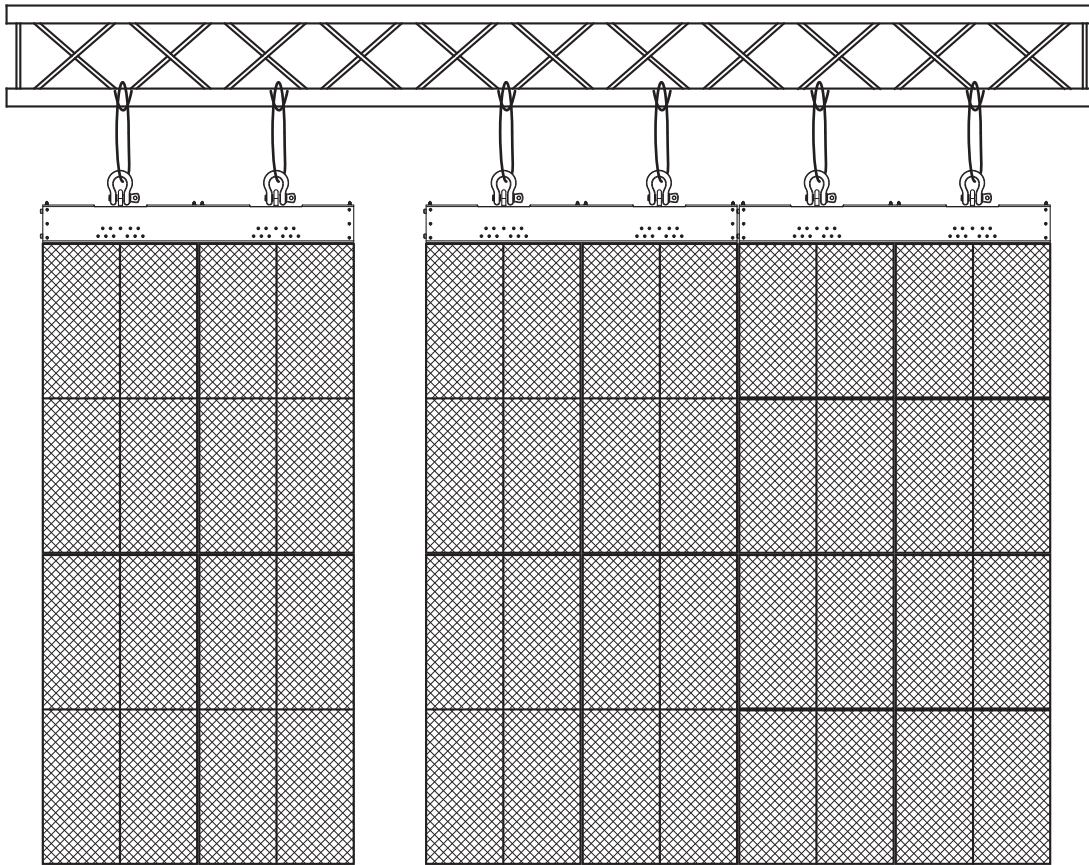

The M12 and M10 mounting points are not intended for hanging or suspending from a truss or other overhead structure.

In order to suspend/hang the panels from a truss or other overhead structure, use the Dual Series Rig Bars (DRB-F50CM or -F100CM, sold separately).



All applicable local codes and regulations apply to proper installation of this product.



WARNING: The alignment magnets on the Dual Function Rig Bars are not designed for load bearing! All Rig Bars in a panel assembly must be mounted individually to the mounting point! Adjacent Rig Bars will NOT support the attached weight!



WARNING: This product should only be used by competent and qualified persons.

Mounting with Dual Function Rig Bar (Stacking)

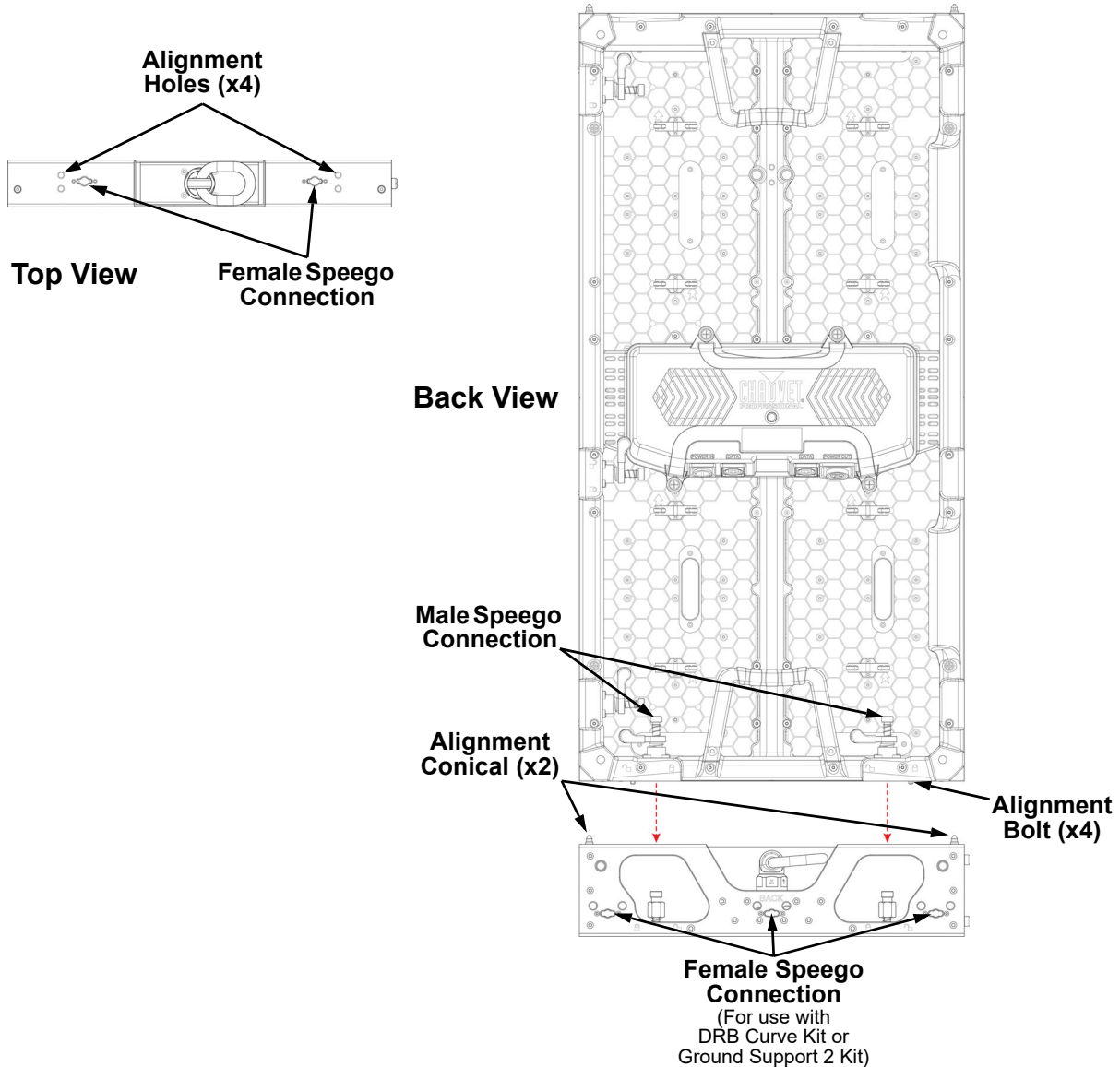

1. Insert alignment conicals into the alignment holes and allow magnets to connect.
2. Close the latches of the male speego connections on the F-series panel.
3. To detach the Rig Bar from the F-Series panel, reverse the previous steps.



Warning! The magnetic attachments are not load-bearing, and are intended for alignment assistance only. Do not release panel until the hanging hardware has been fully secured.

Removing the Feet

To remove the feet (alignment bolts) from the F4XIP, twist them counter-clockwise with a 5 mm wrench until they come loose.



Back View



Side View



Removing the feet may result in damage not covered by the warranty.

Mounting

Flat Wall Installation

Refer to the following diagrams for flat wall installation.

Mounting Points on a Flat Wall

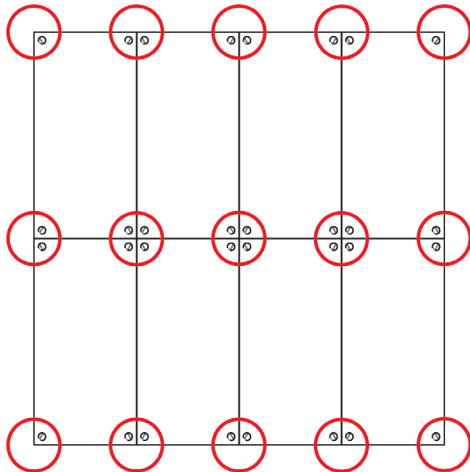

At least 1 mounting point for every junction (circled) must be secured, including outside edges and corners

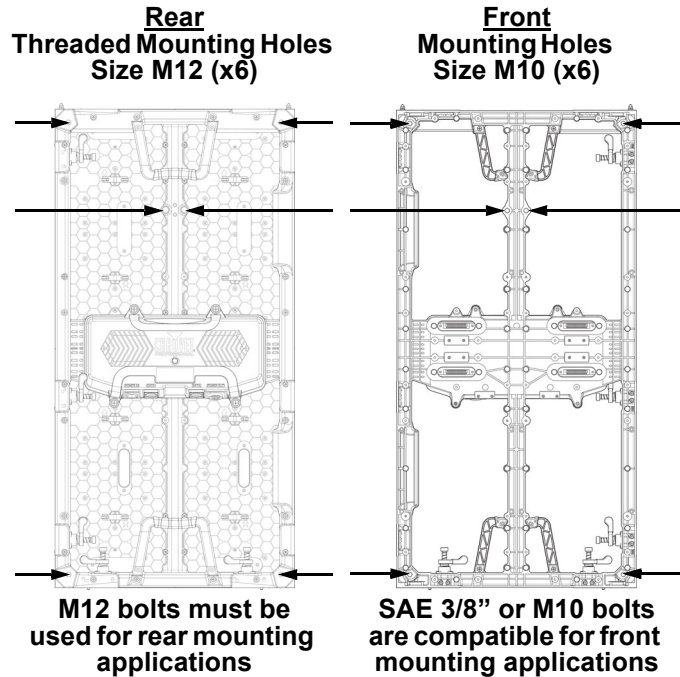

The 4 rear and front mounting holes are intended for flush mount installation to a flat surface against the video panels. 1 mounting point for every junction, including outside edges and corners, must be used in order to maintain structural integrity. The mounting points are not intended for hanging or suspending from a truss or other overhead structure.

The 2 rear mounting holes in the middle of the product are intended for use with the Ground Support 2 Kit from Chauvet.

Mounting with Steel Struts

Chauvet recommends using a VERTICAL steel strut for each column of panels, plus 1, as in the following diagrams:

4 columns + 1
= 5 steel struts

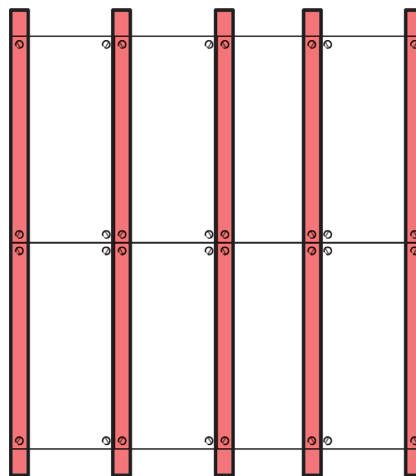

Spacers greater than 5 mm thick must be used at each mounting point, between the panels and the struts.



The illustrations above are examples only. Please refer to all applicable local codes and regulations for the proper installation of the product.

Spacers (Flat Wall Installation)

When mounting to a flat wall, spacers greater than 5 mm thick must be used at each mounting point, between the panels and the struts, as in the diagram below.

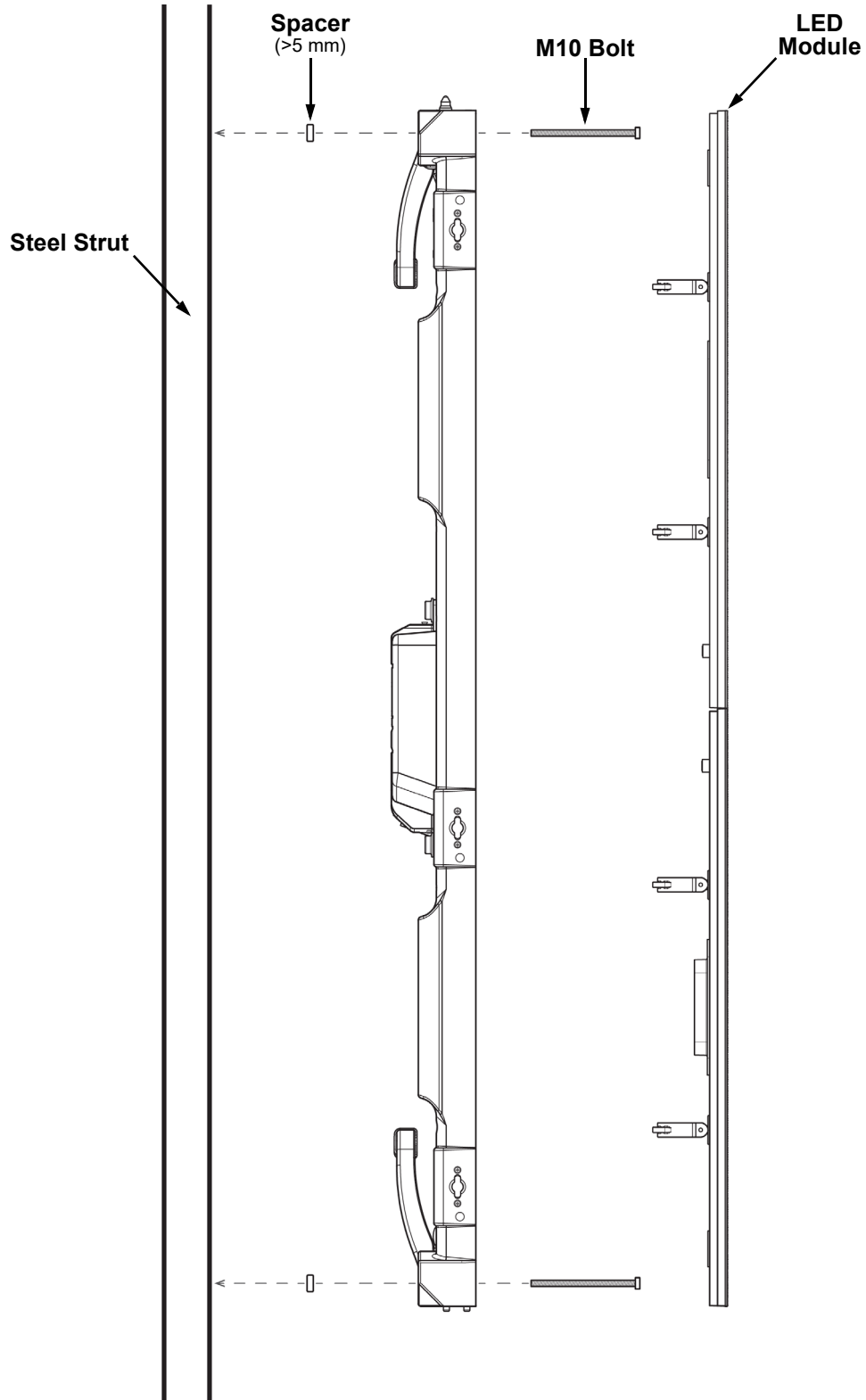

5. Joining Each F4XIP (Creating a Modular Design)

Vertically Joining the Panels

Each F4XIP can be easily joined vertically to a truss using an optional rig bar and the 2 female Speego connections located at the top corners of each panel. Use the male Speego connections at the bottom of each panel to connect additional panels. These connectors stay recessed when not being used.

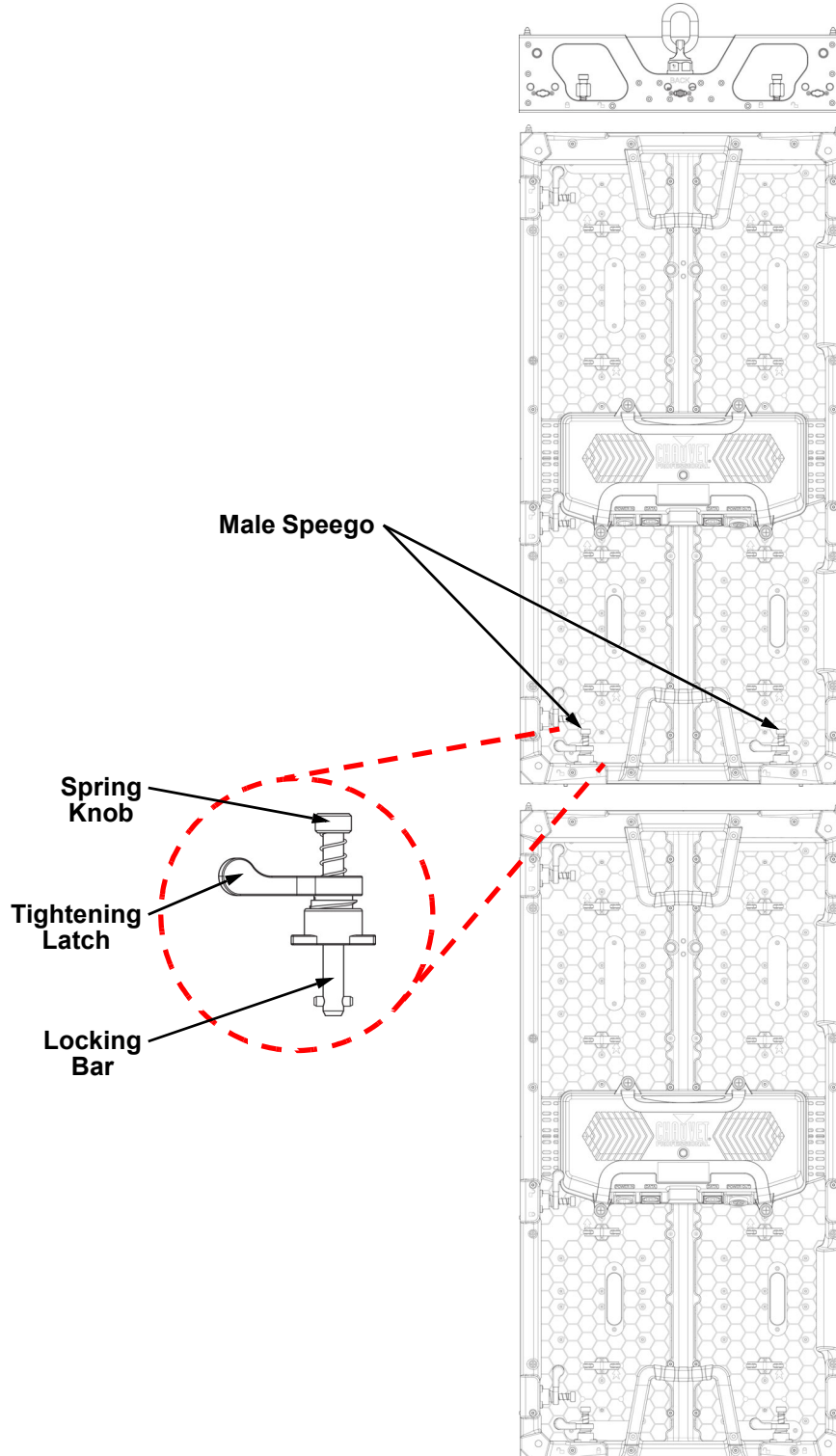

Vertical Panel Connection

Use the following instructions to join panels vertically:

1. Line up the alignment conicals at the top of each panel, and the alignment magnets at the top and bottom of each panel.
2. Push male Speego connections into female Speego connections.
3. Turn the spring knobs clockwise until secure.
4. Turn the tightening latches counter-clockwise until secure.



Due to tolerances in the materials, as well as wear and tear of the latches, some tightening latches may not line up when tightened. This is normal.

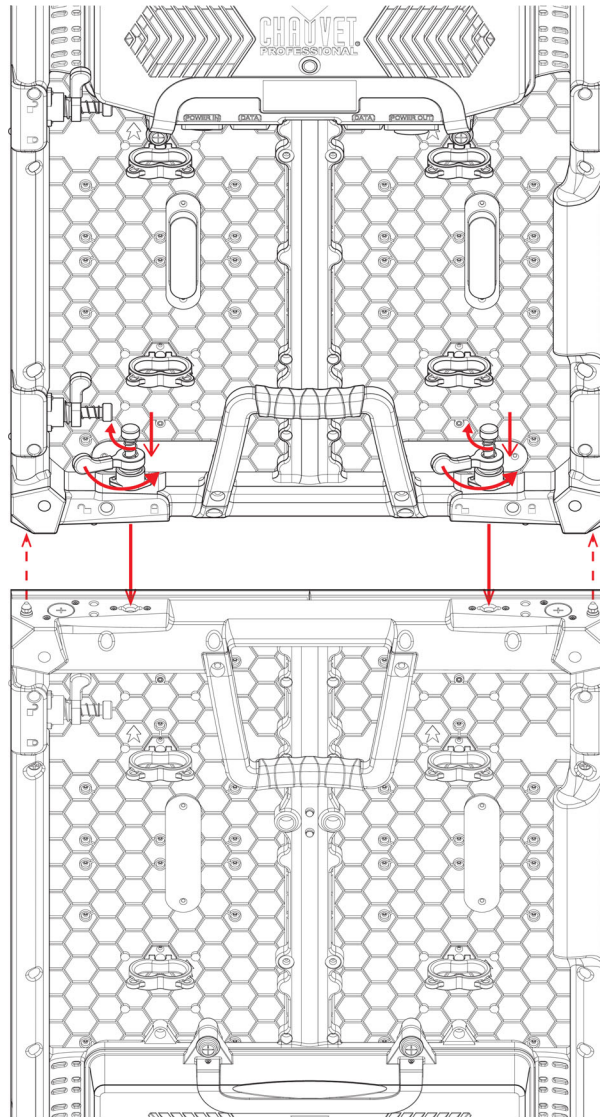

Warning! The magnetic attachments are not load-bearing, and are intended for alignment assistance only. Do not release panel until the hanging hardware has been fully secured.

Joining Each F4XIP (Creating a Modular Design)

Horizontally Joining the Panels

Each F4XIP can be easily joined horizontally using the Speego connections on the inside, upper and lower left sides of each panel.

Horizontal Panel Connection

Use the following instructions to join panels horizontally:

1. Align each of the panels' male Speego connections with the corresponding female connections on the panels being added.
2. Push male Speego connections into female Speego connections.
3. Turn the spring knobs clockwise until secure.
4. Turn the tightening latches counter-clockwise until secure.



Due to tolerances in the materials, as well as wear and tear of the latches, some tightening latches may not line up when tightened. This is normal.

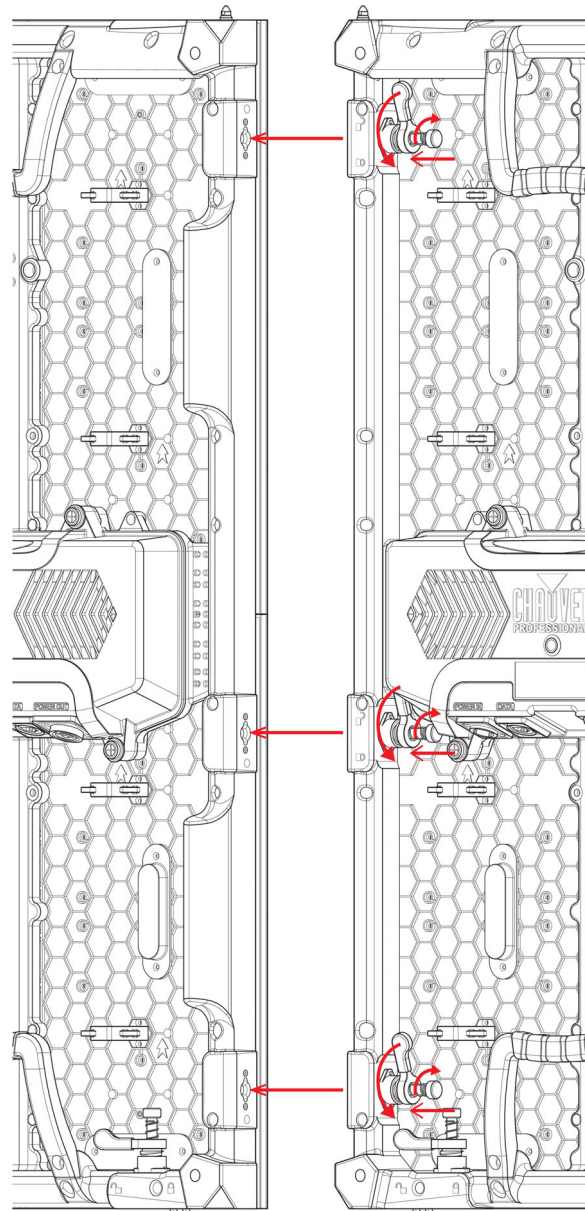

6. Connecting (Cabling) Each F4XIP

Testing Signal and Power Connections

Each F4XIP has 2 power sockets and 2 signal ports.

- The Power and Signal connections are located on the underside of the service module of each panel.
- The Signal ports may be used interchangeably.
- Each F4XIP has LED indicator lights on the test button in the center of the panel.
- Each panel indicates a successful power connection when the Power indicator light remains red.
- Each panel indicates the presence of a signal when the Signal LED indicator light blinks green quickly. When the LED blinks green slowly, there is no signal.

Rear Panel Views

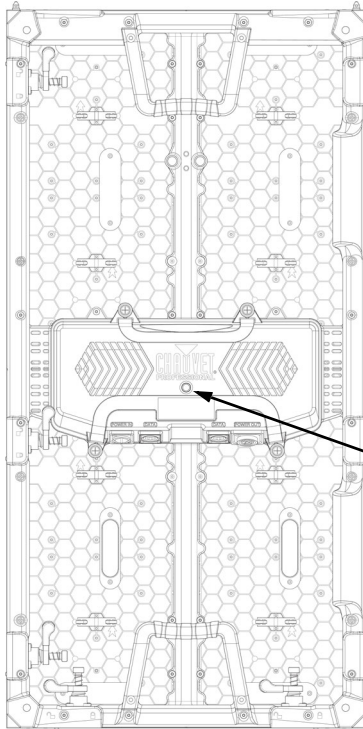

Test Button
Power/Signal
Indicator LEDs

Underside of Service Access Views

Signal Connections

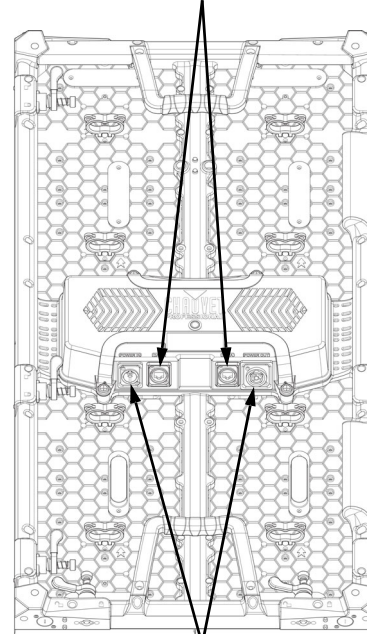

Power In/Out

Using the F4XIP Test Button

Each F4XIP has a Test button, used to ensure all LEDs are functional. Use the Test button on each panel to perform a self-test. If self-testing, you must perform the test individually for each F4XIP. You do not need to connect to a signal or use software.



When using the Test button, make sure the F4XIP is NOT connected to the VIP Drive 10-5 Nova or VIP Drive 83R Nova.

To use the Test button, you must connect the power, but do not connect the signal cables. Press the Test button to toggle through various LED light display configurations.

Connecting (Cabling) Each F4XIP

Connecting Power and Signal Cables

The following sections provide information and diagrams on connecting signal and power between panels. Refer to the [Introduction](#) or [Operation](#) sections in this User Manual for available cables and item numbers.

Connecting the Signal Between Joined Panels

Signal cable panel connections can use several different configurations. The basic configuration to connect the signal from one panel to the next is as follows:

1. The source signal is connected to the first panel.
2. A signal cable is then connected from the first panel.
3. The connections continue to daisy-chain until all panels are connected.
4. The route of the cables used to make the signal connections can vary.

The following diagram is a recommended suggestion for simple signal connections between panels.

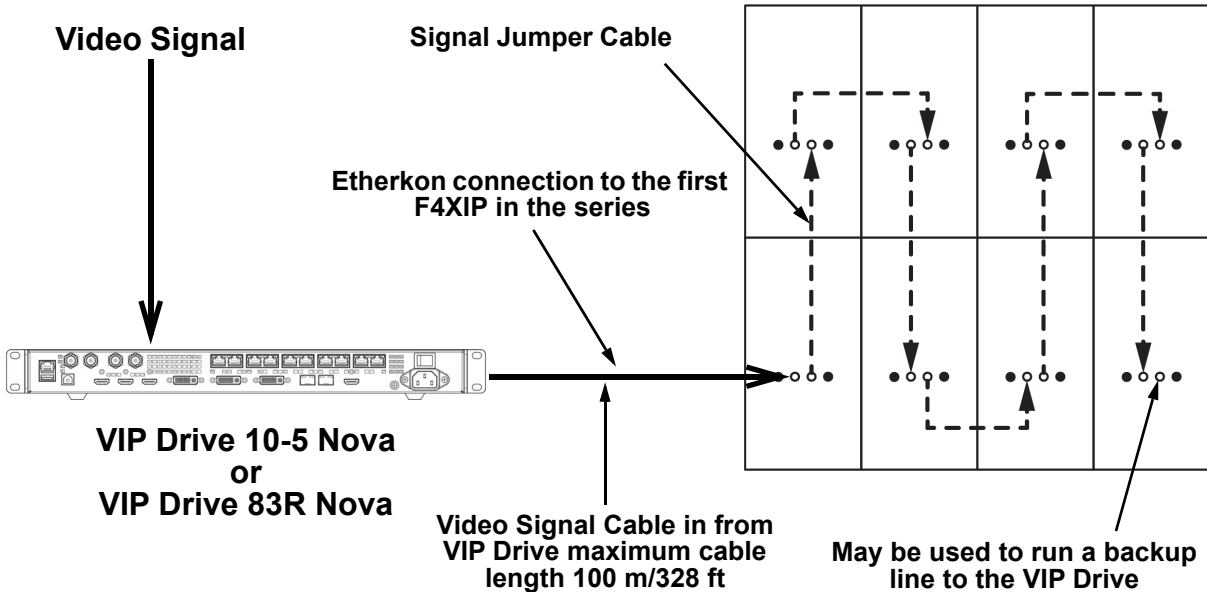

Custom Resolutions

The limitation of how many panels may be added to each port of the VIP Drive 10-5 Nova or VIP Drive 83R Nova may be limited by the input resolution of the drive. Without using a custom refresh rate, rows or columns of pixels may not receive video content.

Example:

- Input resolution: 1920x1080 @ 60Hz
- Panel height: 6 F4XIP (1,248 rows of LEDs)
- Affective rows of LEDs: 1,080
- Blank rows of LEDs: 168

Using this panel configuration with this input resolution may cause distortion. To compensate for this restraint, lower the refresh rate. Doing this can make it possible for a height of up to 10 F4XIP panels at 30 Hz, depending on the resolution width and height.



The Input Resolution for a DVI or HDMI input can be modified in this way, but not for an SDI input.



- **Driver processing capabilities are limited. This means that all input resolutions will not be achievable at all refresh rates.**
- **Increasing the resolution results in a greater overall signal bandwidth, which can put a strain on the processing power of the driver. To reduce the video signal bandwidth and prevent overheating, lower the refresh rate of the input.**

The menu path for these settings is **Input Settings > Custom Resolution**. Select from **Width (H)**, **Height (V)**, or **Custom Refresh Rate** to edit.

If the value of one of these settings stops being able to be increased at any point, the value of one of the other 2 settings must be lowered.

- To continue increasing the **Width (H)**, lower the **Height (V)** or the **Custom Refresh Rate**.
- To continue increasing the **Height (V)**, lower the **Width (H)** or the **Custom Refresh Rate**.

Signal Chain Rectangles (F4XIP)

When panels are assembled together to output video from a VIP Drive 10-5 Nova or a VIP Drive 83R Nova, they form horizontal rows and vertical columns in rectangular arrangements. Each port of one of the above mentioned VIP Drive products can connect to 30 F4XIP panels. If more than 30 panels are used, more than 1 output port from the VIP Drive will be required. Pixels for each port are calculated as whole rectangles. Even if all panels within a rectangle are not connected to a port, the total panels in the rectangle must be within the limits of the port (30 or less). Connecting panels to a single port in an arrangement which creates a rectangle larger than 30 panels will cause errors and problems, even if only 30 panels are actually connected to that port. Of the following examples, only those where both of the following are true can work:

- The number of panels connected to each port is equal to or less than 30.
- The panels connected to each port individually form a rectangle which includes 30 panels or fewer.

Example 1

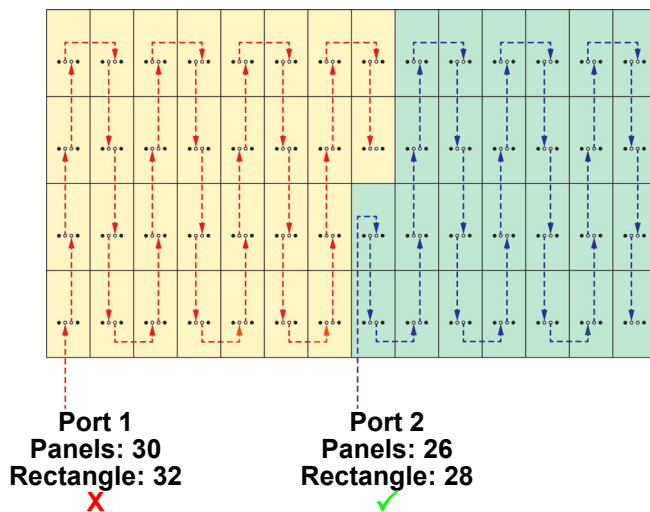

Example 2

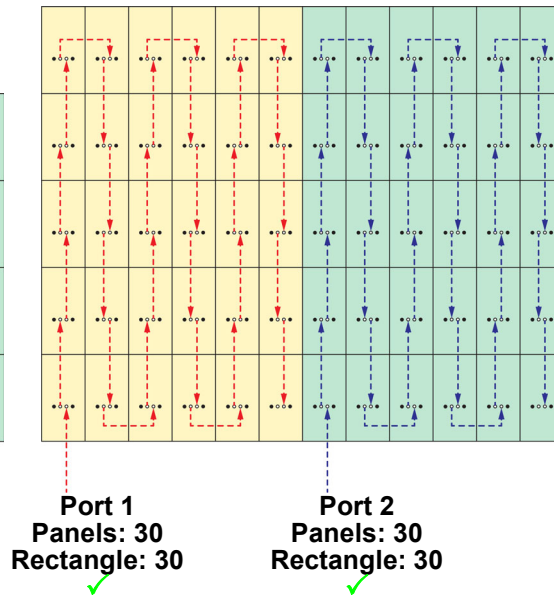

Example 3

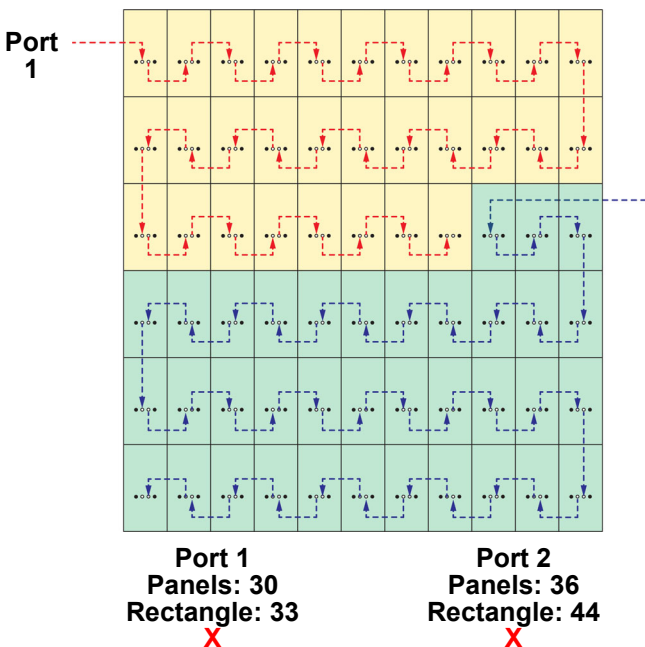

Example 4

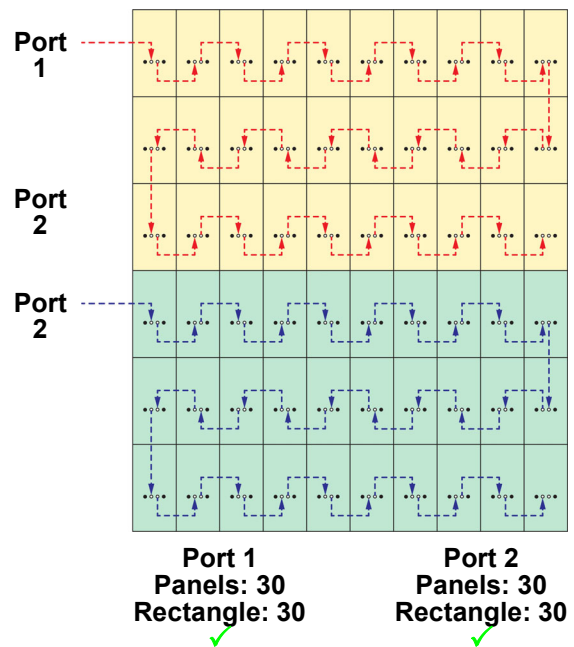

Connecting (Cabling) Each F4XIP

Connecting the Power Between Joined Panels

Power cable panel connections can also use different configurations. The basic configuration to connect the main power supply from one panel to the next is:

1. The main power is connected to the first panel's Power Input or Output.
2. A power cable is then connected to the first panel's Power Output and connected to the next panel's Power Input.
3. The connections continue until all panels are connected.

Connect power between the panels using the same procedure as the signal only using the Power Input and Power Output connectors. You must adhere to the power-linking specifications for each F4XIP model. Refer to the [Power Linking](#) section for details on the number of panels that can be linked based on voltage from a single power connection.



Power linking more panels than recommended will void your warranty and increase the risk of electrocution or fire!

Refer to the following diagrams for an example of power connection from the main and to each connected panel.

This example is using the F4XIP power linking 5 panels horizontally @ 120 V.

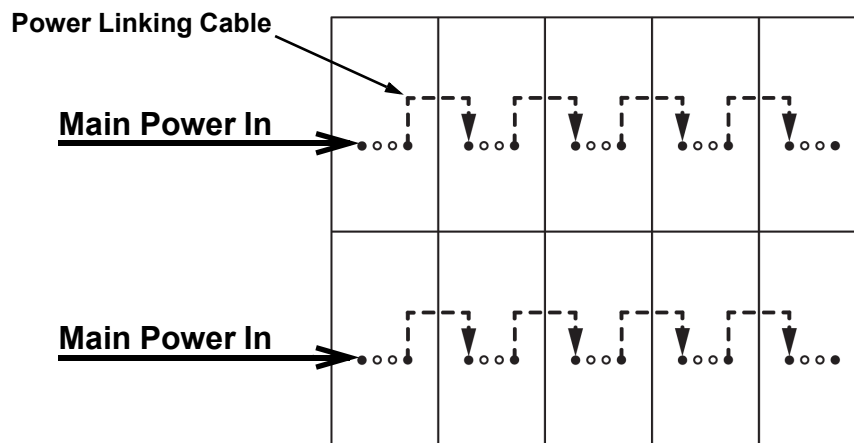

7. LED Module Care and Replacement

F4XIP Modules

Each F4XIP has 4 LED modules connected to the panel frame by magnets and thumb screws. Each module has a single connector that connects to the main processing unit.

LED Lot Numbers

To ensure consistent color matching and output, replace damaged or defective modules with the same LED lot # as the others on the panel. When combining panels to create full video wall systems (rentals, permanent installations, etc.) it is highly recommended that the LED lot #'s on each of the panels match. LED lot #'s can be located on the back of each module.

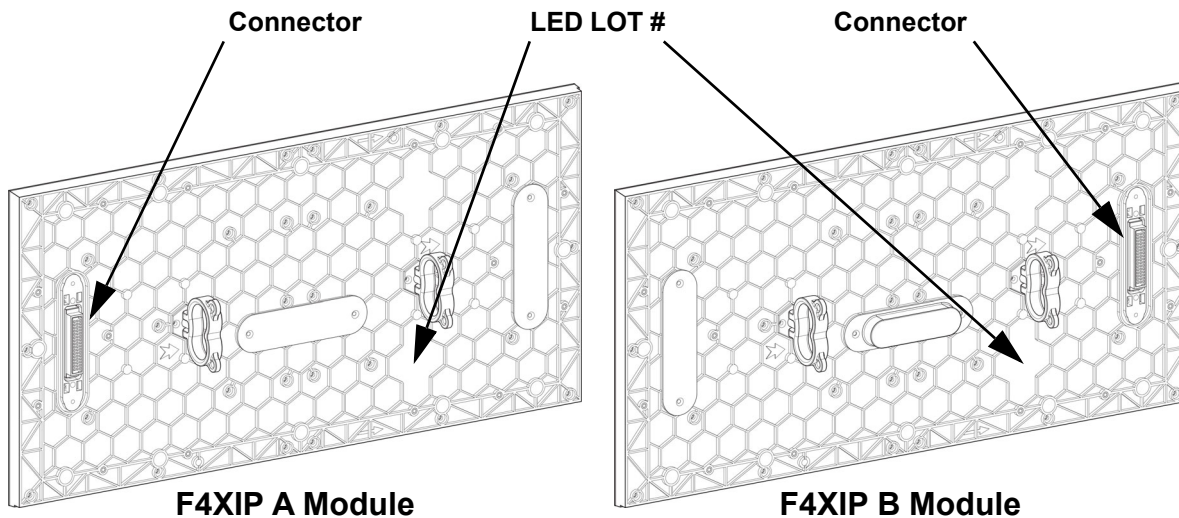

A and B Modules

The F4XIP has 2 types of modules, designed to only plug in to the Service Module from one direction. Check the orientation of the LED LOT # label to determine whether the module is an A type (top half, connector down) or a B type (bottom half, connector up).



The arrows on each module point towards the top of the panel when correctly installed.

Calibration Recall

Each LED module for the F4XIP has individual calibration data for each LED permanently saved to the flash memory of the module. The receiver card inside the control box (or Service module) of the F4XIP can use that data to ensure a uniformity of brightness across the entire panel. To upload the calibration data from a new LED module to the Service Module of the panel, follow the instructions below.

Without a Computer

1. Unplug any signal cables and power the product off.
2. Hold the Test Button down and power the product on.
3. Continue to hold the Test Button down for 10 seconds.
4. Release the Test Button. The signal indicator will flash rapidly while it downloads the calibration data from the module.
5. When the signal indicator stops flashing rapidly, the new module will have been matched automatically to the rest of the panel.

With a Computer

See the Novastar Troubleshooting Guide for instructions on how to perform a calibration recall with a computer.

LED Module Care and Replacement

F4XIP LED Module Removal

LED Module Thumbscrews

Before an LED module can be removed from the F4XIP, 2 thumbscrews must be loosened.

1. Identify the module that needs to be removed.
2. Loosen the 2 thumb screws securing the module to the frame.

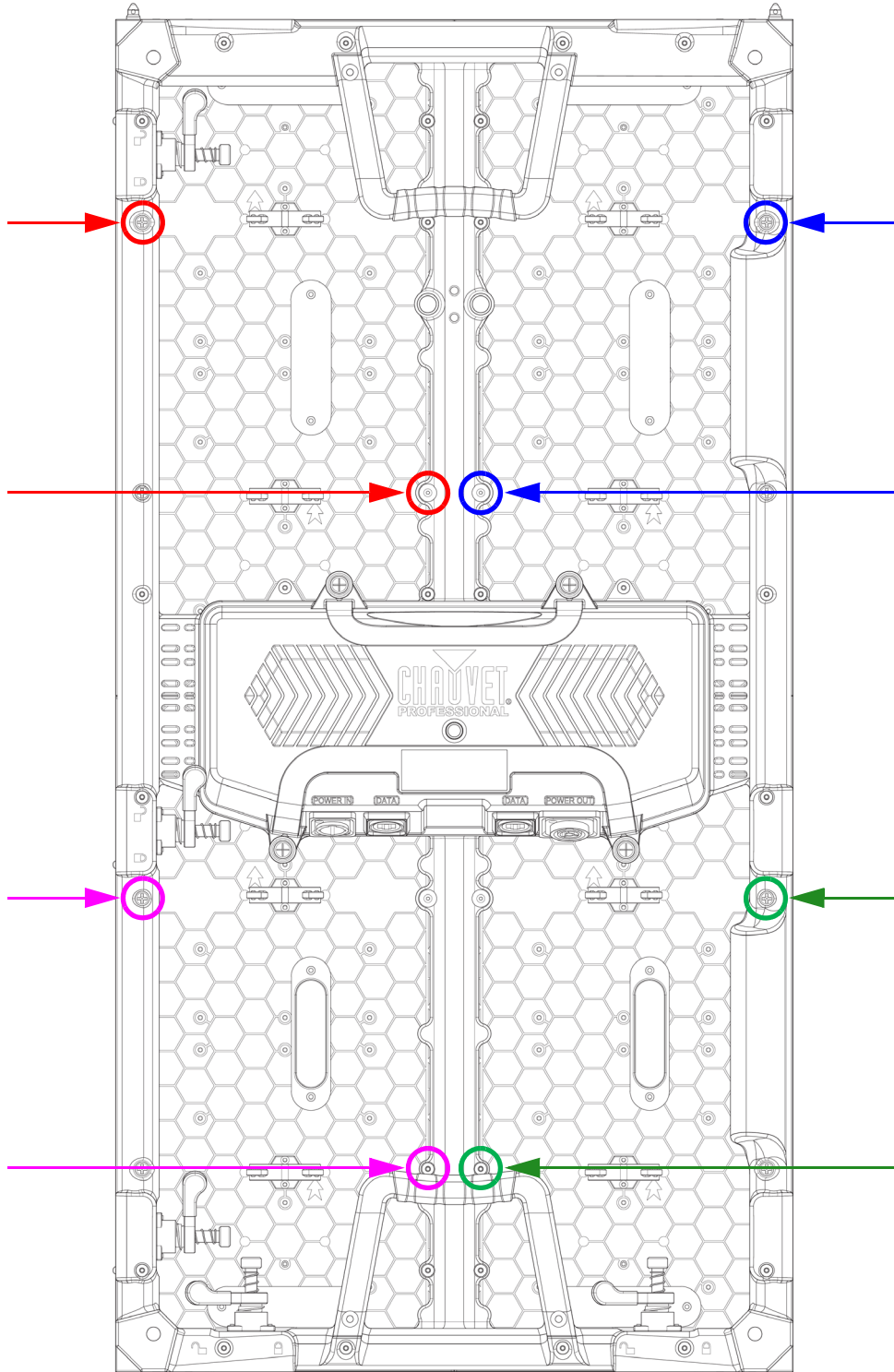

Removing a Module from the Front

To remove an LED module from the front of an F4XIP or F4XIPSQ, use the included front service tool.

1. Follow the instructions under [LED Module Thumbscrews](#).
2. Arrange the front service tool on the module to be removed so that each thumbscrew on the front service tool aligns with a threaded hole on the front of the module.

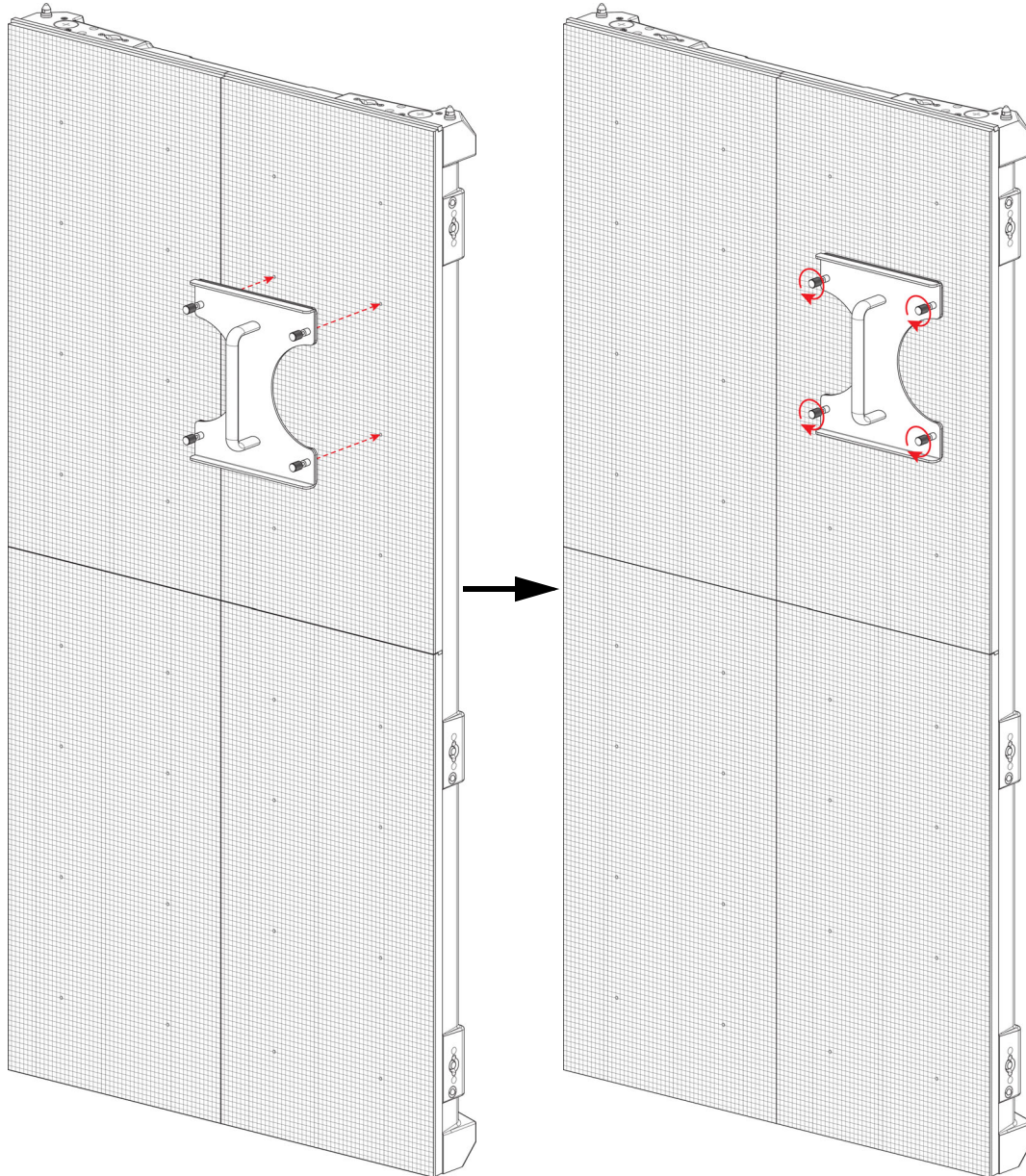

3. Turn the thumbscrews to secure the front service tool to the module.

LED Module Care and Replacement

4. With steadily increasing force and keeping as straight as possible, pull the front service tool away from the frame until the module comes loose with it.

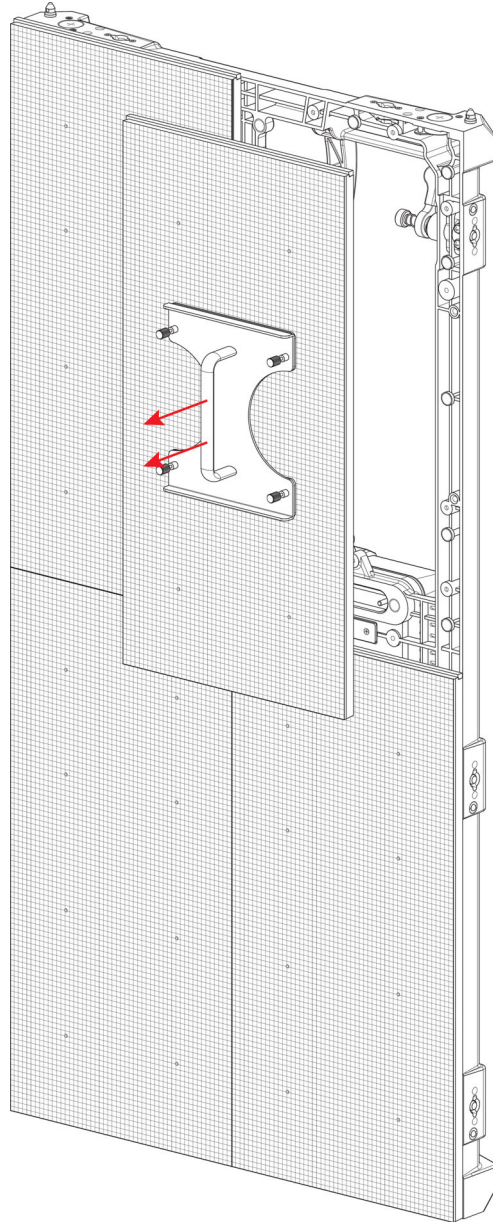

Use caution when removing the module so as not to damage the connector attached to the back of the module.

5. Set the old module on a flat, stable surface, and remove the front service tool by loosening the thumbscrews until it comes free.
6. Reverse the steps to install the replacement module.



WARNING! The magnets on the modules are very powerful! Keep fingers clear when installing.

Removing a Module from the Rear

To remove an LED module from the rear of the F4XIP:

1. Identify which module needs to be removed.
2. Carefully grip the module by the handles from the rear of the panel assembly.

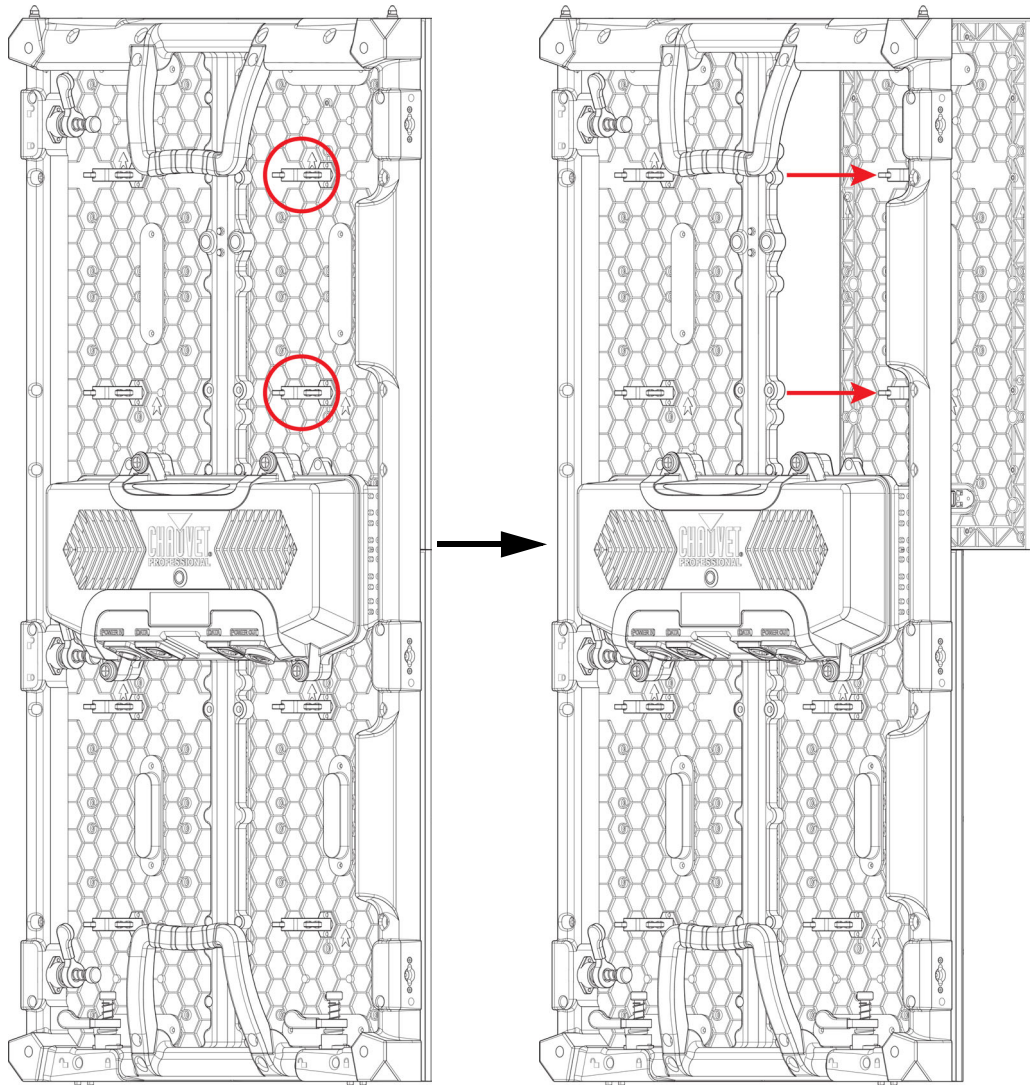

3. With steadily increasing force and keeping as straight as possible, push the module forward away from the frame until it comes loose.



Use caution when removing the module so as not to damage the connector attached to the back of the module.

4. Carefully tilt the module to pull it through to the rear, or have someone on the other side take it.
5. Reverse the steps to install the replacement module.



WARNING! The magnets on the modules are very powerful! Keep fingers clear when installing.

Removing and Replacing the LED Masks

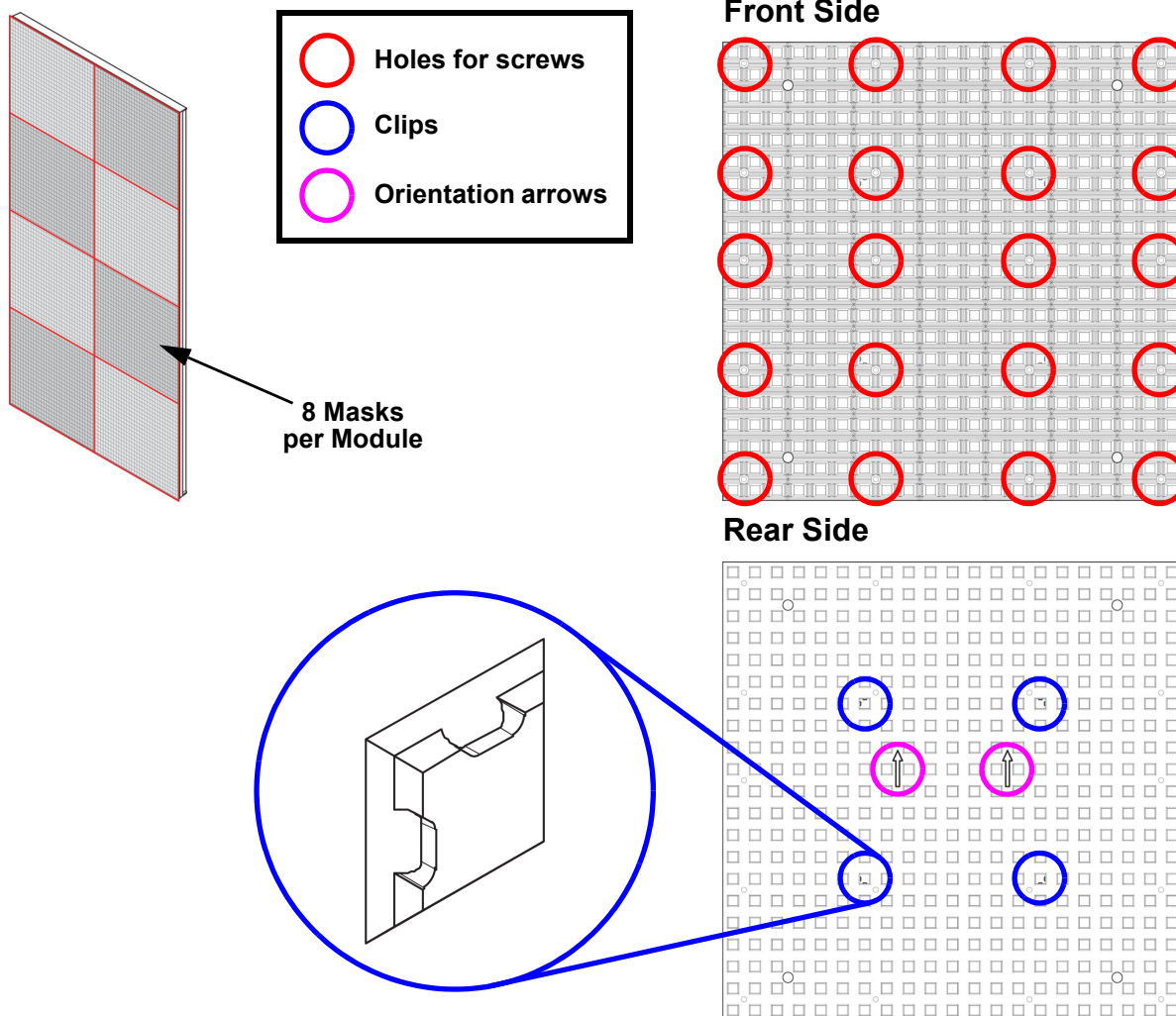

To replace one of the LED masks on an F4XIP LED module, follow the instructions below:

1. Remove the module from the F4XIP (see [F4XIP LED Module Removal](#)).
2. Remove the 20 screws securing the mask with a Phillips-head screwdriver.
3. Gently lift the edges of the mask with a thin prying tool.

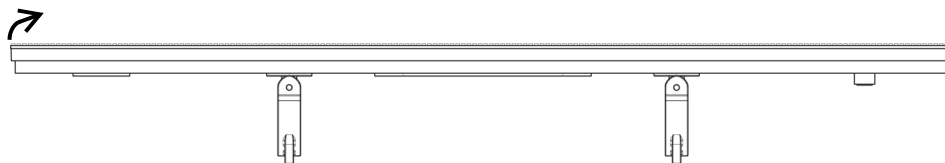

- **A dull plastic prying tool is recommended to prevent LED damage.**
- **Bending the mask too much will permanently stretch it beyond usability.**



- **Take SPECIAL CARE to not pry off any LEDs!**
- **When in doubt, seek expert assistance or advice!**

4. Work the prying tool toward the center, gently lifting the mask from the LEDs.
5. Place the new LED mask in the space, with the rear (clips and arrows) side facing in towards the product. Ensure the orientation arrows point in the same direction as the arrows on the module.
6. Push the mask in firmly until it is completely flush with the rest of the masks on the product. A roller tool is recommended for this procedure.
7. Secure in place with the 20 screws.

8. F4XIP Serviceability

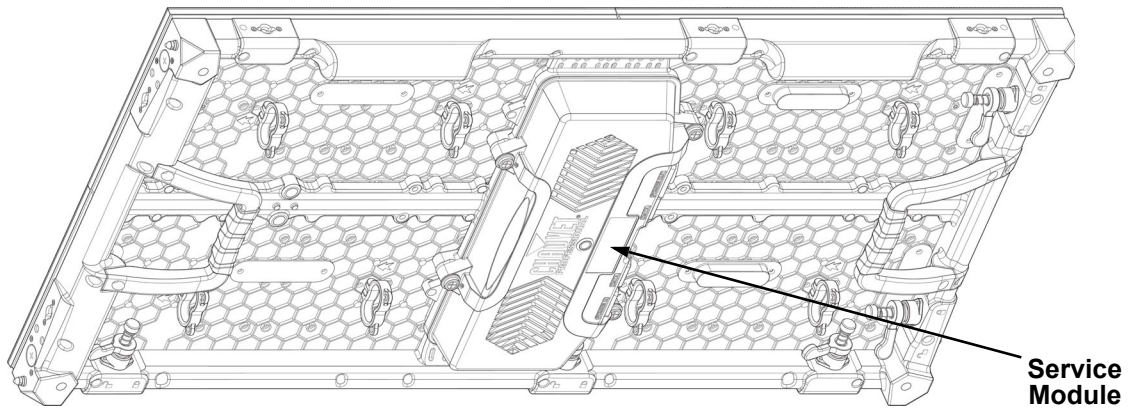

The F4XIP service module can be accessed and serviced from either the front of the panel or the rear of the panel at any time, so panels can be serviced when access to either the front or the rear is restricted or impossible.

To access the F4XIP service module from the front of the panel:

1. Remove the modules as described in [LED Module Care and Replacement](#).

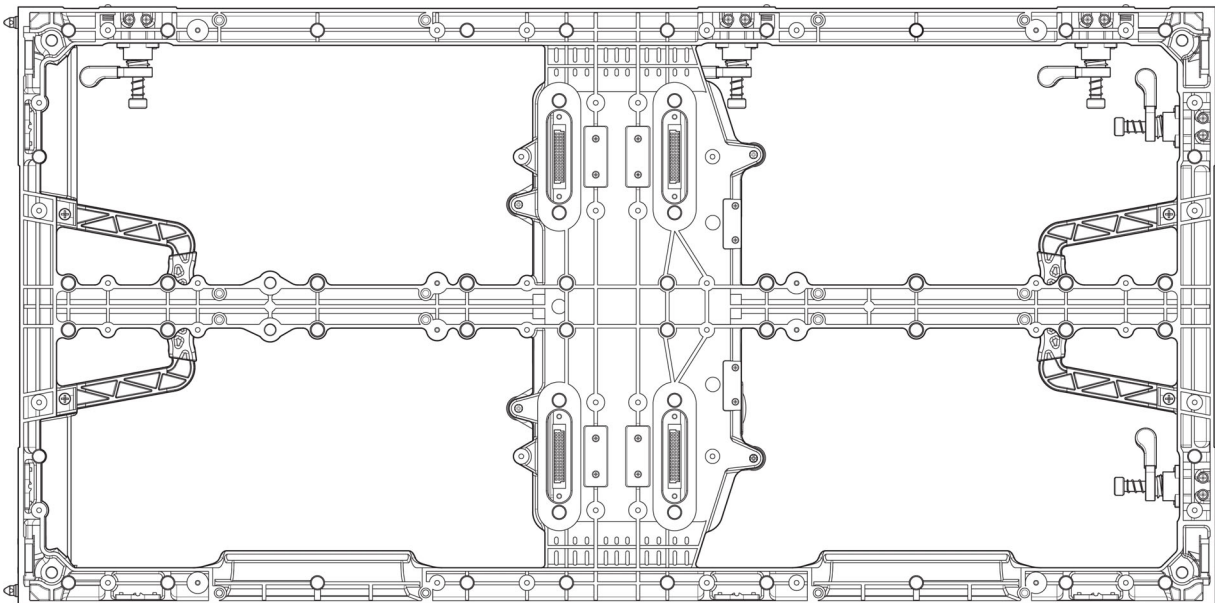

2. Remove four Phillips-head screws.

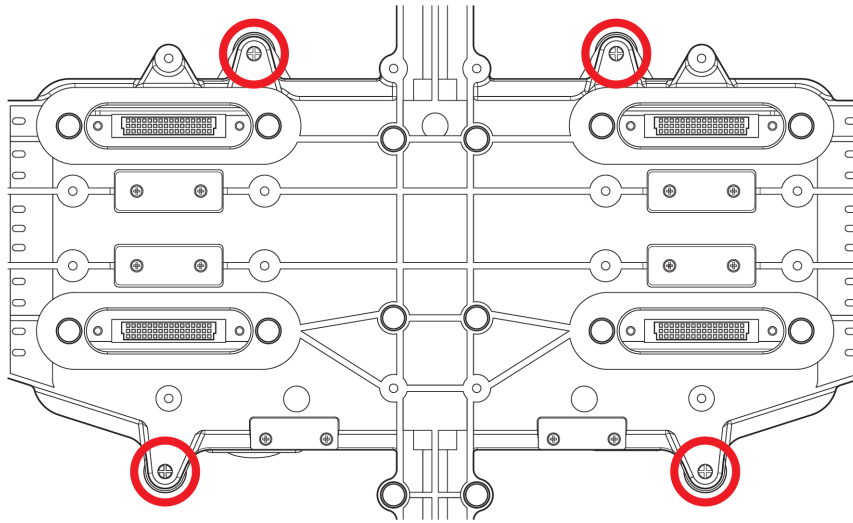

Use caution when removing these screws, as the cover of the service module will be detached from the panel frame. All components in the service module are attached to the cover.

To access the F4XIP service module from the rear of the panel, remove the 4 screws indicated in the diagram below.

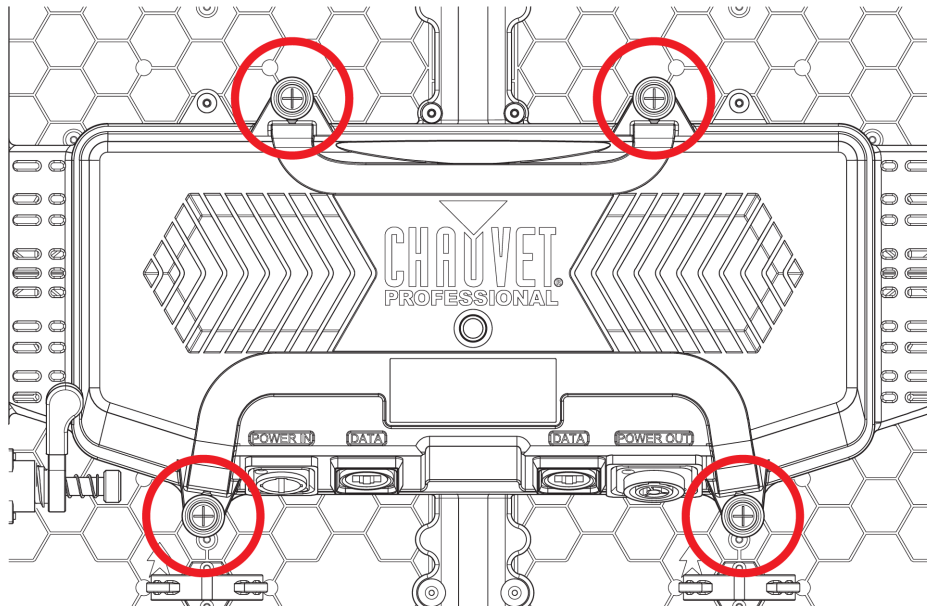

Use caution when removing these screws, as the cover of the service module will be detached from the panel frame. All components in the service module are attached to the cover.

9. Typical F4XIP Installation (Hanging)

Because a video wall system can include different components to provide a simple to complex modular wall design, use the following steps as a general guide to get started.

Step 1

Open and examine the F4XIP road case to make sure all products and accessories have been received and that each one is in good condition.

Step 2

Apply power and run the self-test for each F4XIP to ensure all LEDs and inside connections in each panel are working (optional).

Step 3

Create a stable mounting surface (e.g., truss or other stable surface) for F4XIP mounting.

Step 4

Mount the first top row of the F4XIP products. Refer to the [Mounting](#) section in this User Manual.

Step 5

Adjust the alignment of the first row using the Speego connectors / latches.

Step 6

Connect the signal source to the VIP Drive 10-5 Nova or VIP Drive 83R Nova.

Step 7

Connect the VIP Drive to the Signal port of the first panel in your connection chain.

Step 8

Based on the video wall configuration (design), join each panel, horizontally and/or vertically, using the instructions in the section [Joining Each F4XIP \(Creating a Modular Design\)](#).

Refer to the instructions and information in the [Connecting \(Cabling\) Each F4XIP](#) section of this User Manual,

10. Operation

Additional Hardware and Software

In addition to the panels, you will need other hardware and software to design, build, and operate the F4XIP video wall system. The following table summarizes these additional items—some are required and others are optional.

Item	Description
VIP Drive 10-5 Nova or VIP Drive 83R Nova	Interface between the signal source, NovaLCT, and the F4XIP being used
NovaLCT and/or SmartLCT	Software applications used to design and run the F4XIP products comprising the video wall. A PC is needed
DRB-F50CM or DRB-F100CM F-Series Dual Function Rig Bar (optional)	Provides hardware needed to mount F4XIP
Neutrik® etherCON® Signal (optional)	Neutrik etherCON CAT6 extension cable, 18 in Neutrik etherCON CAT6 extension cable, 5 ft Neutrik etherCON CAT6 extension cable, 10 ft Neutrik etherCON CAT6 extension cable, 25 ft Neutrik etherCON CAT6 extension cable, 50 ft
IP65 Rated Seetronic® Powerkon Extension (optional)	IP65 Rated Seetronic® Powerkon Extension, 5 ft IP65 Rated Seetronic® Powerkon Extension, 10 ft IP65 Rated Seetronic® Powerkon Extension, 25 ft
VIP Media System	Rack mountable video computer system
ArKaos MediaMaster	Video playback software

About NovaLCT and SmartLCT

NovaLCT and SmartLCT are powerful and easy-to-learn software applications used to design and run the F4XIP video wall system. The following is some introductory information about these applications.

Refer to the VIP Drive 10-5 Nova or VIP Drive 83R Nova User Manual for detailed information and instructions on setting up and using NovaLCT and SmartLCT with the Chauvet F4XIP video wall system.

Description

NovaLCT and SmartLCT enable the creation and control of a video wall by addressing the panels included in the video wall including pixel pitch and layout.

Once having physically created the modular video wall design by joining the panels, connecting power, signals, and the VIP Drive 10-5 Nova or VIP Drive 83R Nova, recreate that design within NovaLCT.

Detailed information and instructions are in the User Manuals for the VIP Drive 10-5 Nova and the VIP Drive 83R Nova.



Chauvet does not recommend using NovaLCT or SmartLCT for live show playback. For this purpose, Chauvet offers Arkaos MediaMaster, which offers numerous playback triggers, including DMX, Art-Net, MA-net, MIDI, and QWERTY.

Receiver Card Configuration Files

Receiver Card Configuration Files, commonly referred to as RCFGX files, contain all of the data used to route video signal data from the receiver card to the LED drivers inside the F4XIP panels. This data includes:

- LED module layout and quantity
- LED driver model
- Scan mode (number of LEDs in a series)
- Refresh rate
- Grayscale
- Maximum brightness
- Total panel orientation (when compatible)
- Gamma table (dimming curve)
- The signal indicator LED on/off function
- Panel power consumption
- Panel dimensions
- LED quantity
- LED module flash configuration

The RCFGX file does not contain brightness/chroma calibration data or mapping data (panel layout). Each of these are stored as separate files. To load a new RCFGX file onto an F4XIP panel, follow the steps under [Updating RCFGX Files \(NovaLCT\)](#) or [Updating RCFGX Files \(SmartLCT\)](#).



Ensure the RCFGX file version matches the firmware version on the panel.

Updating RCFGX Files (NovaLCT)

To update the RCFGX files of F4XIP products through NovaLCT:

1. Connect the VIP Drive being used to a computer with NovaLCT installed.
2. Open the NovaLCT software.
3. Click **User (U)** in the menu running across the top of the window to open the drop-down menu.

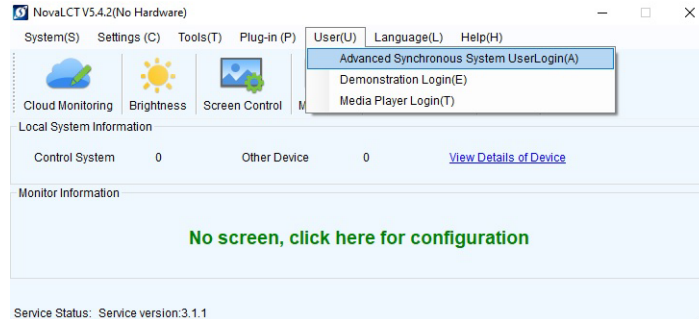

4. Click **Advanced Synchronous System UserLogin(A)**.

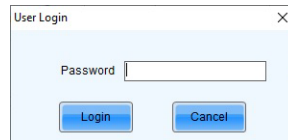

5. Type **admin** into the password field, and click the **Login** button on the screen, or press the **Enter** key.
6. Open **Screen Configuration**.

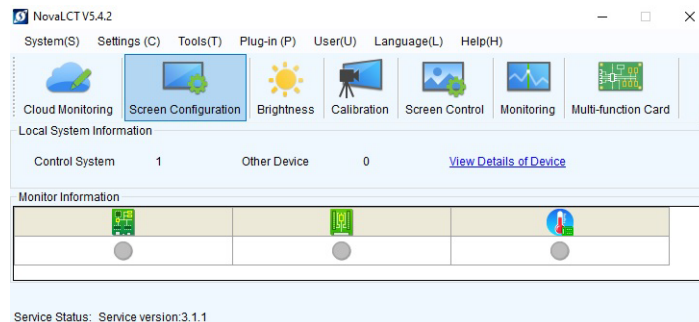

7. Select the appropriate communications port for the connected panel assembly from the drop-down list.

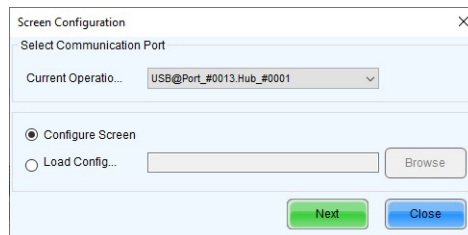

8. Click **Next**.

- In the Screen Configuration window, navigate to the **Receiving Card** tab.

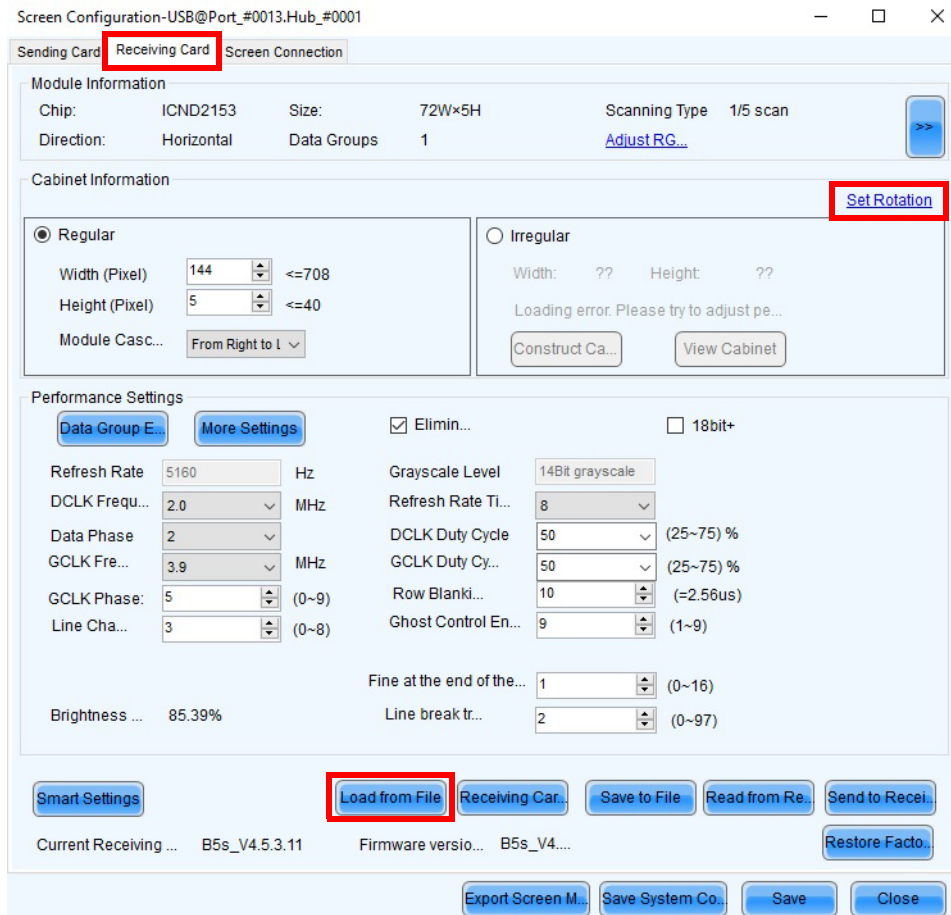

- Click **Load from File**.
- Select the RCFGX file to load. The latest version can be downloaded from www.chauvetvideo.com.
- When the file is loaded successfully, press **OK** to close the confirmation window.

Rotating the Video Panel Orientation (NovaLCT)

When mounting F4XIP panels sideways (90° or 270°), their orientation must be set in the mapping software. To do this through NovaLCT

- If the RCFGX files of the panels are up to date, follow steps 1-9 under [Updating RCFGX Files \(NovaLCT\)](#). If the RCFGX files are not up to date, follow steps 1-12.
- Click the **Set Rotation** hyperlink which appears in the upper right corner of the **Cabinet Information** section of the **Receiving Card** tab.

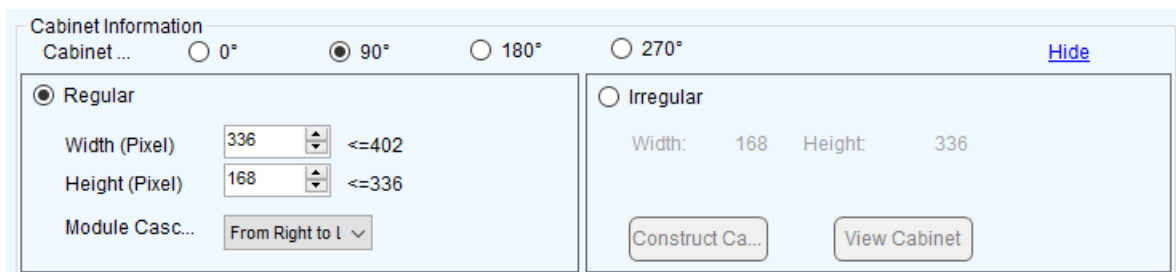

- Select either **90°** or **270°** to rotate the video within the connected panels.



The size of the Receiving Card will be changed accordingly from 128x256 to 256x128. If using the software to map a panel assembly, these values must be used as the Receiving Card parameters of the NovaLCT software.

Updating RCFGX Files (SmartLCT)

To update the RCFGX files of F4XIP products through SmartLCT.

1. Connect the VIP Drive being used to a computer with SmartLCT installed.
2. Open the SmartLCT software.
3. Open a saved design or create a new design and map the products as needed.
4. Select the desired products (of the same type) from the products which are mapped.

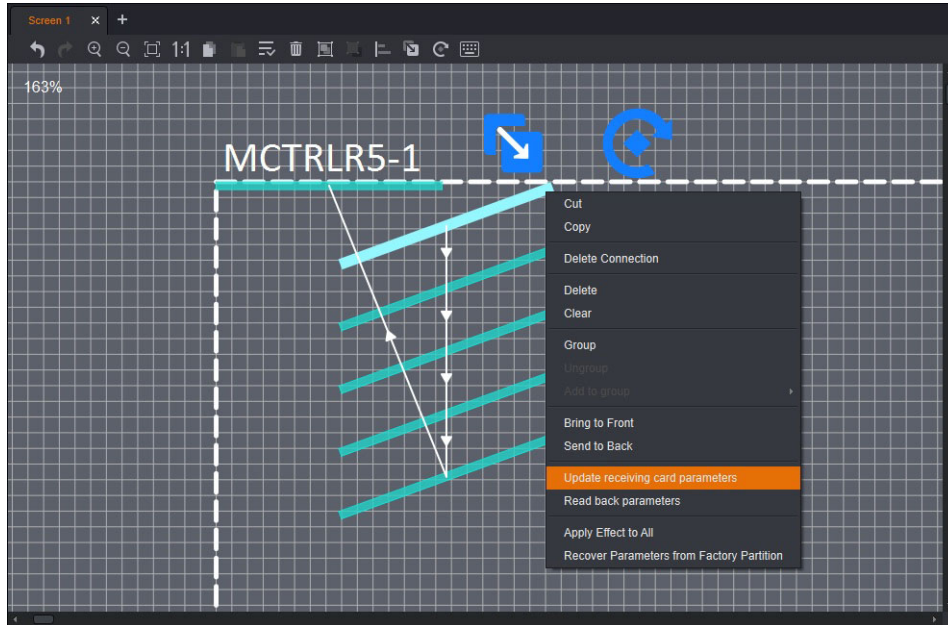

5. Right click on one of the selected products (F6 Strip IP from Chauvet Professional shown for example purposes only).
 - If one product is selected, **Read back parameters** can be selected, which will download the RCFGX file from that product to the computer.
6. Select **Update receiving card parameters**.
7. Click the button to the right of the field under **From local rcfgx file**, and browse to find and select the RCFGX file.

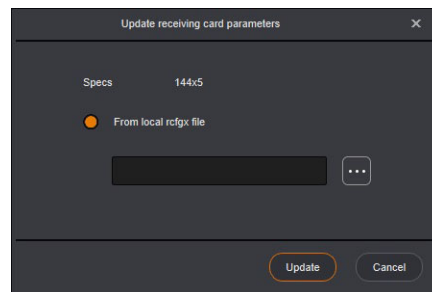

8. Click **Update**.

11. Technical Information

F4XIP Maintenance

To maintain optimum performance and minimize wear, the user should clean this product regularly. Usage and environment are contributing factors in determining the cleaning frequency.

As a rule, clean this product at least twice a month. Dust build-up reduces light output performance and can cause overheating. This can lead to reduced light source life and increased mechanical wear.

To clean an F4XIP, follow the recommendations below:

1. Unplug the panel from power.
2. Wait until the product is at room temperature.
3. Use a soft brush to remove dust collected on the external components.
4. Wipe the outside of the LED Modules with a soft, lint-free cloth dampened with isopropyl alcohol. Apply gentle pressure only.
5. Make sure all connections are thoroughly dry before reconnecting power and signal cables.



Always dry the external surfaces carefully after cleaning them.

Returns

You must send the product prepaid, in the original box, and with the original packing and accessories. Chauvet will not issue call tags.

Call Chauvet and request a Return Merchandise Authorization (RMA) number before shipping the product. Be prepared to provide the model number, serial number, and a brief description of the cause(s) for the return.

To submit a service request online, go to www.chauvetprofessional.com/service-request.

Clearly label the package with an RMA number. Chauvet will refuse any product returned without an RMA number.



DO NOT write the RMA number directly on the box. Instead, write it on a properly affixed label.

Once you have received the RMA number, include the following information on a piece of paper inside the box:

- Your name
- Your address
- Your phone number
- The RMA number
- A brief description of the problem(s)

Be sure to pack the product properly. Any shipping damage resulting from inadequate packaging will be the customer's responsibility. FedEx packing or double-boxing is recommended.



Chauvet reserves the right to use its own discretion to repair or replace returned product(s).

12. Technical Specifications

Optical

Light Source	Red Wavelength	Green Wavelength	Blue Wavelength
Tri-color RGB SMD 1921 LED	615 to 630 nm	512 to 535 nm	460 to 475 nm
Pixels per Panel	Pixel Pitch (between LEDs)	Pixel Density	Display Refresh Rate
104 x 208 (21,632 total)	4.8 mm	43,264/m ²	3,840 Hz (S-PWM)
Viewing Angle (H/V) 140°	Calibrated Illuminance	Maximum Illuminance	
	4,500 NITS	5,000 NITS	

Power

Power Supply Type	AC Voltage Range	Voltage Selection	
Switching	100–240 VAC, 50/60 Hz	Auto-ranging	
Parameter	120 V, 60 Hz	208 V, 60 Hz	230 V, 50 Hz
Power Consumption	370 W, 3.09 A	360 W, 1.75 A	359 W, 1.58 A
Power Linking	5 units	8 units	9 units

Construction/Physical

Dimensions	Weight	
19.69 x 2.56 x 39.37 in (500 x 65 x 1000 mm)	30 lb (13.6 kg)	
Transparency	Housing Material	Operating Temperature
0%	Magnesium die-cast	-4 °F to 104 °F (-20 °C to 40 °C)

Connections

Power Connection	Data Connection	Control Protocol
Seetronic Powerkon [®] IP65	Seetronic Etherkon [®] IP65	Novastar
Maximum Panels per VIP Drive 43Nova 2	Maximum Panels per VIP Drive 83R Nova	Maximum Panels per VIP Drive 10-5 Nova
30/port, 108/drive (4 ports) (up to 120/drive if overlapping video content)	30/port, 216/drive (8 ports) (up to 240/drive if overlapping video content)	30/port, 216/drive (10 ports) (up to 300/drive if overlapping video content)

Notes for all Drives: Increasing refresh rate reduces port capacity. Adding mapping space between panels reduces port capacity.

Max. Wide/VIP Drive 43Nova 2	Max. Wide/VIP Drive 83R Nova	Max. Wide/VIP Drive 10-5 Nova
18 @ 1920 wide resolution	36 @ 3840 wide resolution	36 @ 3840 wide resolution
Max. Tall/VIP Drive 43Nova 2	Max. Tall/VIP Drive 83R Nova	Max. Tall/VIP Drive 10-5 Nova
6 @ 60 Hz 5 @ 30 Hz	6 @ 60 Hz 7 @ 30 Hz	6 @ 60 Hz 10 @ 30 Hz

Ordering

Product Name	Item Name	Item Code	UPC Number
F4XIP (4-Pack Road Case)	F4XIPX4	23091665	781462220136

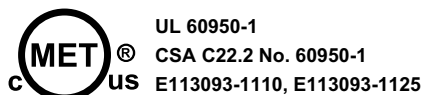

Contact Us

General Information	Technical Support
World Headquarters	
Address: 5200 NW 108th Ave. Sunrise, FL 33351 Voice: (954) 577-4455 Fax: (954) 929-5560 Toll Free: (800) 762-1084	Voice: (844) 393-7575 Fax: (954) 756-8015 Email: chauvetcs@chauvetlighting.com Website: www.chauvetprofessional.com
U.K.	
Address: Unit 1C Brookhill Road Industrial Estate Pinxton, Nottingham, UK NG16 6NT Voice: +44 (0) 1773 511115 Fax: +44 (0) 1773 511110	Email: UKtech@chauvetlighting.eu Website: www.chauvetprofessional.eu
Benelux	
Address: Stokstraat 18 9770 Kruishoutem Belgium Voice: +32 9 388 93 97	Email: BNLtech@chauvetlighting.eu Website: www.chauvetprofessional.eu
France	
Address: 3, Rue Ampère 91380 Chilly-Mazarin France Voice: +33 1 78 85 33 59	Email: FRtech@chauvetlighting.fr Website: www.chauvetprofessional.eu
Germany	
Address: Bruno-Bürgel-Str. 11 28759 Bremen Germany Voice: +49 421 62 60 20	Email: DEtech@chauvetlighting.de Website: www.chauvetprofessional.eu
Mexico	
Address: Av. de las Partidas 34 - 3B (Entrance by Calle 2) Zona Industrial Lerma Lerma, Edo. de México, CP 52000 Voice: +52 (728) 690-2010	Email: servicio@chauvet.com.mx Website: www.chauvetprofessional.mx

Visit the applicable website above to verify our contact information and instructions to request support. Outside the U.S., U.K., Ireland, Benelux, France, Germany, or Mexico, contact the dealer of record.